

650G

series

This manual was downloaded on www.sdsdrives.com
+44 (0)117 938 1800 - info@sdsdrives.com



**Software
Product
Manual**

HA501038U001



650G AC Drive

Software Product Manual

HA501038U001 Issue 1

Compatible with Version 1.x Software onwards

2010 Parker SSD Drives, a division of Parker Hannifin Ltd.

All rights strictly reserved. No part of this document may be stored in a retrieval system, or transmitted in any form or by any means to persons not employed by a Parker SSD Drives company without written permission from Parker SSD Drives, a division of Parker Hannifin Ltd. Although every effort has been taken to ensure the accuracy of this document it may be necessary, without notice, to make amendments or correct omissions. Parker SSD Drives cannot accept responsibility for damage, injury, or expenses resulting therefrom.

WARRANTY

Parker SSD Drives warrants the goods against defects in design, materials and workmanship for the period of 24 months from the date of manufacture, or 12 months from the date of delivery (whichever is the longer period), on the terms detailed in Parker SSD Drives Standard Conditions of Sale IA500504.

Parker SSD Drives reserves the right to change the content and product specification without notice.

FAILURE OR IMPROPER SELECTION OR IMPROPER USE OF THE PRODUCTS DESCRIBED HEREIN OR RELATED ITEMS CAN CAUSE DEATH, PERSONAL INJURY AND PROPERTY DAMAGE.

This document and other information from Parker-Hannifin Corporation, its subsidiaries and authorized distributors provide product or system options for further investigation by users having technical expertise.

The user, through its own analysis and testing, is solely responsible for making the final selection of the system and components and assuring that all performance, endurance, maintenance, safety and warning requirements of the application are met. The user must analyze all aspects of the application, follow applicable industry standards, and follow the information concerning the product in the current product catalog and in any other materials provided from Parker or its subsidiaries or authorized distributors.

To the extent that Parker or its subsidiaries or authorized distributors provide component or system options based upon data or specifications provided by the user, the user is responsible for determining that such data and specifications are suitable and sufficient for all applications and reasonably foreseeable uses of the components or systems.

Safety Information



Requirements

IMPORTANT: Please read this information BEFORE installing the equipment.

Intended Users

This manual is to be made available to all persons who are required to install, configure or service equipment described herein, or any other associated operation.

The information given is intended to highlight safety issues, EMC considerations, and to enable the user to obtain maximum benefit from the equipment.

Complete the following table for future reference detailing how the unit is to be installed and used.

INSTALLATION DETAILS	
Model Number <i>(see product label)</i>	
Where installed <i>(for your own information)</i>	
Unit used as a: <i>(refer to Certification for the Inverter)</i>	<input type="radio"/> Component <input type="radio"/> Relevant Apparatus
Unit fitted:	<input type="radio"/> Wall-mounted <input type="radio"/> Enclosure



Application Area

The equipment described is intended for industrial motor speed control utilising DC motors, AC induction or AC synchronous machines

Personnel

Installation, operation and maintenance of the equipment should be carried out by qualified personnel. A qualified person is someone who is technically competent and familiar with all safety information and established safety practices; with the installation process, operation and maintenance of this equipment; and with all the hazards involved.

Product Warnings

	Caution Risk of electric shock		Caution Refer to documentation		Earth/Ground Protective Conductor Terminal
-------------------------------------------------------------------------------------	------------------------------------------	-------------------------------------------------------------------------------------	------------------------------------------	---------------------------------------------------------------------------------------	------------------------------------------------------

Safety Information



Hazards

DANGER! - Ignoring the following may result in injury

1. This equipment can endanger life by exposure to rotating machinery and high voltages.
2. The equipment must be permanently earthed due to the high earth leakage current, and the drive motor must be connected to an appropriate safety earth.
3. Ensure all incoming supplies are isolated before working on the equipment. Be aware that there may be more than one supply connection to the drive.
4. There may still be dangerous voltages present at power terminals (motor output, supply input phases, DC bus and the brake, where fitted) when the motor is at standstill or is stopped.
5. For measurements use only a meter to IEC 61010 (CAT III or higher). Always begin using the highest range. CAT I and CAT II meters must not be used on this product.
6. Allow at least 5 minutes for the drive's capacitors to discharge to safe voltage levels (<50V). Use the specified meter capable of measuring up to 1000V dc & ac rms to confirm that less than 50V is present between all power terminals and earth.
7. Unless otherwise stated, this product must NOT be dismantled. In the event of a fault the drive must be returned. Refer to "Routine Maintenance and Repair".

WARNING! - Ignoring the following may result in injury or damage to equipment

SAFETY

Where there is conflict between EMC and Safety requirements, personnel safety shall always take precedence.

- Never perform high voltage resistance checks on the wiring without first disconnecting the drive from the circuit being tested.
- Whilst ensuring ventilation is sufficient, provide guarding and /or additional safety systems to prevent injury or damage to equipment.
- When replacing a drive in an application and before returning to use, it is essential that all user defined parameters for the product's operation are correctly installed.
- All control and signal terminals are SELV, i.e. protected by double insulation. Ensure all external wiring is rated for the highest system voltage.
- Thermal sensors contained within the motor must have at least basic insulation.
- All exposed metalwork in the Inverter is protected by basic insulation and bonded to a safety earth.
- RCDs are not recommended for use with this product but, where their use is mandatory, only Type B RCDs should be used.

EMC

- In a domestic environment this product may cause radio interference in which case supplementary mitigation measures may be required.
- This equipment contains electrostatic discharge (ESD) sensitive parts. Observe static control precautions when handling, installing and servicing this product.
- This is a product of the restricted sales distribution class according to IEC 61800-3. It is designated as "professional equipment" as defined in EN61000-3-2. Permission of the supply authority shall be obtained before connection to the low voltage supply.

CAUTION!

APPLICATION RISK

- The specifications, processes and circuitry described herein are for guidance only and may need to be adapted to the user's specific application. We can not guarantee the suitability of the equipment described in this Manual for individual applications.

RISK ASSESSMENT

Under fault conditions, power loss or unintended operating conditions, the drive may not operate as intended.

In particular:

- Stored energy might not discharge to safe levels as quickly as suggested, and can still be present even though the drive appears to be switched off
- The motor's direction of rotation might not be controlled
- The motor speed might not be controlled
- The motor might be energised

A drive is a component within a drive system that may influence its operation or effects under a fault condition.

Consideration must be given to:

- Stored energy
- Supply disconnects
- Sequencing logic
- Unintended operation

Contents

<i>Contents</i>	<i>Page</i>
CHAPTER 1 PROGRAMMING YOUR APPLICATION	1-1
Programming with Block Diagrams	1-1
Modifying a Block Diagram Over Comms	1-1
Function Block Descriptions	1-3
Understanding the Function Block Description	1-3
Function Blocks by Category	1-4
Function Blocks in Alphabetical Order	1-5
Normal/Heavy Duty Selection	1-82
CHAPTER 2 PARAMETER SPECIFICATION	2-1
Specification Table: Tag Number Order	2-2
MMI Parameters	2-13
Pref Cross Reference Table	2-16
Product-Related Default Values	2-17
* Frequency Dependent Defaults	2-17
** Power Dependent Defaults	2-18
CHAPTER 3 SERIAL COMMUNICATIONS	3-1
Communications Technology Options	3-1
DSE	3-1
Connection to the P3 Port	3-1
CHAPTER 4 SEQUENCING LOGIC STATES	4-1
Principle State Machine	4-1
Main Sequencing States	4-1
State Outputs of the SEQUENCING LOGIC Function Block	4-1
Transition of States	4-2
State Diagram	4-3
External Control of the Drive	4-4
Communications Command	4-4
Communications Status	4-6
CHAPTER 5 APPLICATIONS	5-1
The Default Application	5-1
How to Load an Application	5-1
Application Description	5-1
Application 1: Basic Speed Control (default)	5-3
Application 2: Auto/Manual Control	5-5
Application 3: Preset Speeds	5-7
Application 4: Raise/Lower Trim	5-9
Application 5: PID	5-11
Application Control Blocks	5-12

Chapter 1 PROGRAMMING YOUR APPLICATION

You can program the drive to your specific application. This programming simply involves changing parameter values. Access the parameters using the keypad, or DSE (or other suitable programming tool).

Each Application recalls a pre-programmed set of default parameters and links when it is loaded.

Refer to Chapter 5: “Applications” for further information.

Programming with Block Diagrams

Block diagram programming provides a visual method of planning the software to suit your application. There are block diagrams provided at the end of this chapter, each showing the software connections for an Application. These pages replicate the DSE programming screens. DSE is Parker SSD Drive’s own programming tool.

The processes performed by an Application are represented as a block diagram, consisting of *function blocks* and *links*:

- Each function block contains the parameters required for setting-up a particular processing feature. Sometimes more than one instance of a function block is provided for a feature, i.e. for multiple digital inputs.
- Software links are used to connect the function blocks. Each link transfers the value of an output parameter to an input parameter of another (or the same) function block.

Each individual block is a processing feature, i.e. it takes the input parameter, processes the information, and makes the result available as one or more output parameters.

Modifying a Block Diagram Over Comms

Configuration and Parameterisation Modes

There are two modes of operation used while modifying a block diagram: *Configuration* and *Parameterisation* modes.

Configuration Mode

In the Configuration Mode you can modify the links in the function block diagram. You can also change parameter values, as above. The drive cannot run in this mode.

When you attempt to change a parameter value requiring Configuration Mode to be enabled, the drive automatically enters Configuration Mode.

Once in Configuration Mode, to return to Parameterisation Mode simply press the **E** key repeatedly.

Parameterisation Mode

In parameterisation mode you can change parameter values. The drive can be running or stopped. Note that some parameters can only be changed when the drive is stopped. It is not possible to modify the internal links when the drive is in parameterisation mode.

DEFAULT

1-2 Programming Your Application

Execution Rules

The complete block diagram is executed every 5ms. Just before a function block is executed, all the links that have that block as their destination are executed, thereby copying new values in to the block's parameter inputs. The input parameters are then processed to produce a new set of output parameters. The execution order of the blocks is automatically arranged for minimal delay.

- The output value transferred by a link on execution is clamped to be between the maximum and minimum value for its destination input parameter.
- Refer to the table below for the result of linking different parameter types.

Source Value (the input)	Source Type	Destination Type	Destination Value (the result)
TRUE	Boolean	Real	0.01
FALSE	Boolean	Real	0.00
≥ 0.005	Real	Boolean	TRUE
≤ 0.005	Real	Boolean	FALSE
LOCAL ONLY (1)	Enumerated	Real	1.00
2.00	Real	Enumerated	REMOTE ONLY (2) (Note that (2) will not always return Remote Only)

Table 1-1 Execution Rules

Saving Your Modifications

Whenever a value/link is changed, the modification is stored automatically and will be saved on power-down.

Function Block Descriptions

Note: To view all parameters available on the MMI, Full menu detail must be selected in the DETAILED MENUS parameter (ST99). Additional blocks/parameters are available over the Comms.

Understanding the Function Block Description

The following function blocks show the parameter information necessary for programming the drive.

Input parameters are shown on the left hand side, and output parameters are shown on the right hand side of the block.

The diagrams assume that the UK country code is selected and that a 400V 11kW Frame C power board is fitted. This is reflected in the values of certain parameters, see “*” and “**” in the table below.

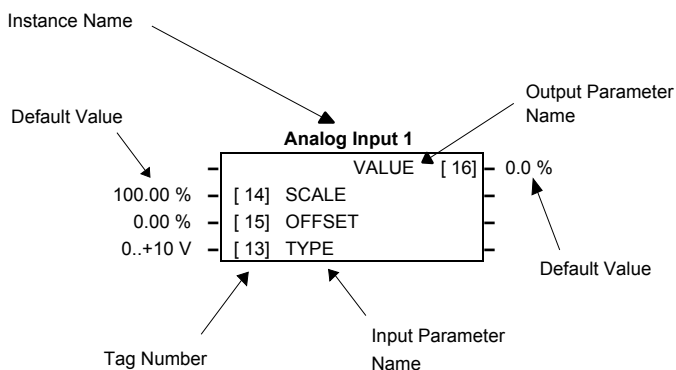

Figure Chapter 1-1 Function Block Parameter Information

Instance Name	Names the function block and MMI menu
Default Value	The default value of the unmodified macro, Macro 0
Input/Output Parameter Name	The name shown on DSE
Tag Number	Unique identification used for communications
*	Parameters marked with “*” are set to a value depending upon the “operating frequency” of the drive. Refer to Chapter 2: “Parameter Specification” - Frequency Dependent Defaults; and the Installation Product Manual, Chapter 5: “The Operator Station” - Changing the Product Code (3-button reset).
**	Parameters marked with “**” are set to a value depending on the overall “power build” of the drive indicated by the product code. Refer to Chapter 2: “Parameter Specification” - Power Dependent Defaults; and the Installation Product Manual: Chapter 2: “Understanding the Product Code”.

Note: The “Range” for a parameter value is given in the Parameter Description Table on each Function Block page. Ranges for outputs are given as “—xx %”, for example, indicating an indeterminate integer for the value, to two decimal places.

F	Parameters indicated with F are visible with Full menus only. Refer to the DETAILED MENUS parameter (ST 99) in the MMI ACCESS function block, page 1-42.
M	Parameters indicated with M are Motor Parameters. They are not reset by changing Application using parameter ^P 1; all other parameters are reset to default values.
VF	Parameters indicated with VF are only visible when the drive is in VF (Volts/Hz) motor control mode, as selected by parameter ^S CL01.
SV	Parameters indicated with SV are only visible when the drive is in SV (Sensorless Vector) motor control mode, as selected by parameter ^S CL01.

1-4 Programming Your Application

Function Blocks by Category

The function block descriptions in this chapter are arranged in alphabetical order, however, they are listed below by Category.

Communications

COMMS PORTS 1-15

Configuration

APP CONFIG 1-8

Encoder Functions

ENCODER 1-24

Hoist/Lift

BRAKE CONTROL 1-13

Inputs/Outputs

ANALOG INPUT	1-5	DIGITAL INPUT	1-20
ANALOG OUTPUT	1-7	DIGITAL OUTPUT	1-21

Menus

CUSTOM MENU	1-18	MMI ACCESS	1-42
-------------	------	------------	------

Miscellaneous

DEMULTIPLEXER	1-19	MULTIPLEXER	1-45
LOGIC FUNCTION	1-37	VALUE FUNCTION	1-73

Motor Control

AUTOTUNE	1-12	INVERSE TIME	1-34
CURRENT LIMIT	1-17	MOTOR DATA	1-42
DISPLAY/KEYPAD	1-22	PATTERN GEN	1-46
DYNAMIC BRAKING	1-23	SLEW RATE LIMIT	1-62
ENERGY METER	1-25	SLIP COMP	1-63
FEEDBACKS	1-26	SPEED LOOP	1-64
FLUXING	1-28	STABILISATION	1-66
FLYCATCHING	1-31	TORQUE LIMIT	1-68
INJ BRAKING	1-33	VOLTAGE CONTROL	1-80

Sequencing and Referencing

AUTO RESTART	1-11	REFERENCE JOG	1-54
COMMS CONTROL	1-14	REFERENCE RAMP	1-55
LOCAL CONTROL	1-36	REFERENCE STOP	1-57
REFERENCE	1-52	SEQUENCING LOGIC	1-58

Setpoint Functions

AT LOAD	1-9	PRESET	1-49
AT SPEED	1-10	RAISE/LOWER	1-51
MINIMUM SPEED	1-41	SKIP FREQUENCIES	1-60
PID	1-47	ZERO SPEED	1-81

Trips

I/O TRIPS	1-35	TRIPS HISTORY	1-69
STALL TRIP	1-67	TRIPS STATUS	1-70

Function Blocks in Alphabetical Order

ANALOG INPUT

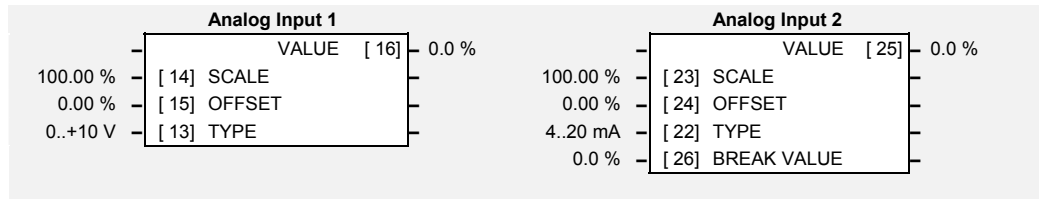

The analog input block converts the input voltage or current into a value expressed as a percentage of a configurable range.

Parameter Descriptions

SCALE *SET/IN IP11 & IP21* *Range: -300.00 to 300.00 %*

A scaling factor applied to the raw input. With a scaling factor of 100.00% and an offset of 0.00%, an input equal to the low input range will appear as a value of 0.00%. Similarly, an input equal to the high input range will appear as a value of 100.00%.

OFFSET *SET/IN IP12 & IP22* *Range: -300.00 to 300.00 %*

An offset added to the input after the scaling factor has been applied.

TYPE *SET/IN IP13 & IP23* *Range: Enumerated - see below*

The input range and type.

ANALOG INPUT 1 supports Types 0 and 1 only. ANALOG INPUT 2 support all types.

Enumerated Value : TYPE

- 0 : 0..+10 V
- 1 : 0..+5 V
- 2 : 0..20 mA
- 3 : 4..20 mA

BREAK VALUE *Range: -100.0 to 100.0 %*

The value that will appear as the VALUE output when BREAK is TRUE

VALUE *SET/IN IPA1 & IPA2* *Range: —.x %*

The input reading with scaling and offset applied.

1-6 Programming Your Application

Functional Description

The drive has two analog inputs. There is an analog input function block for each:

ANALOG INPUT 1 is associated with the signal on terminal 2

ANALOG INPUT 2 is associated with the signal on terminal 3

The input voltage is pre-processed and converted into a numeric value by the analog input electronics of the drive. The analog input function blocks further process this reading so that a value of 0.00% represents an input equal to the low input range, while a value of 100.00% represents an input equal to the high input range. The SCALE and OFFSET factors are then applied as shown to produce a value suitable for use in the application.

The break detect facility is only used in conjunction with the "4 to 20mA" hardware range. An input break is defined as an input reading less than either 0.1V or 0.45mA. When an input break has been detected, the VALUE output is forced to be the BREAK VALUE.

If you don't want the break detect facility, select the "0 to 20mA". You can also apply OFFSET to recreate the "4 to 20mA" hardware range.

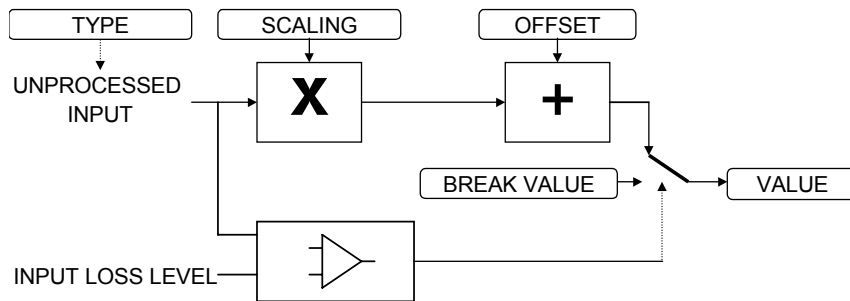

ANALOG OUTPUT

The analog output block converts the demand percentage into a form suitable for driving the analog output electronics of the drive.

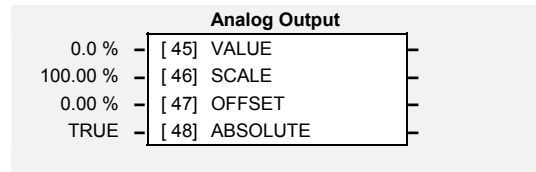

Parameter Descriptions

VALUE *SET/OUT OP05* *Range: -300.0 to 300.0 %*
The demanded value to output.

SCALE *SET/OUT OP02* *Range: -300.00 to 300.00 %*
A scaling factor to apply to VALUE . A scaling factor of 100.00% has no effect.

OFFSET *SET/OUT OP03* *Range: -300.00 to 300.00 %*
An offset added to VALUE after the scaling factor has been applied. An offset factor of 0.00% has no effect.

ABS *SET/OUT OP04* *Range: FALSE / TRUE*
When TRUE the output sign is ignored.

Functional Description

The drive has one analog outputs:

ANALOG OUTPUT 1 is associated with terminal 6

The scaling and offset parameters are applied to the demand value as shown.

If ABS is TRUE then the final output is the magnitude of value after being scaled and offset and the output sign is ignored

If ABS is FALSE then as above, except that the output sign is valid.

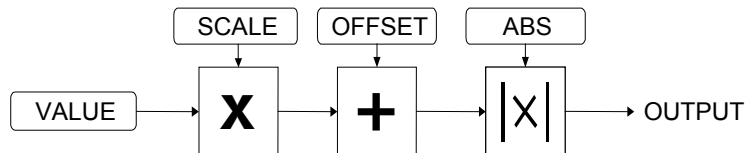

1-8 Programming Your Application

APP CONFIG

This block controls the selection of user application and of the output wiring

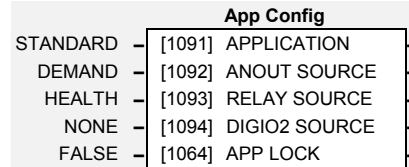

Parameter Descriptions

APPLICATION *PAR\PI* *Range: Enumerated - see below*

This parameter selects and loads the Application to be used. APP 0 will not control a motor. APP 6, 7 & 8 are for future use. You can edit an Application in DSE and, then set this parameter to CUSTOM to produce your own custom Application.

Refer to Chapter 5: "Applications" which gives detailed information about each Application.

- 0 : NULL
- 1 : STANDARD
- 2 : LOCAL/REM (AUTO/MANUAL)
- 3 : PRESETS
- 4 : RAISE/LOWER
- 5 : PID
- 6 : APP 6
- 7 : APP 7
- 8 : APP 8
- 9 : CUSTOM

ANOUT SOURCE *SET/OUT OP01* *Range: Enumerated - see below*

The source of the analog output, terminal 5. An internal link is made to one of the following parameters:

- 0 : NONE *No link is made*
- 1 : DEMAND *SPEED DEMAND in the REFERENCE block*
- 2 : CURRENT *MOTOR CURRENT% in the FEEDBACKS block*
- 3 : PID ERROR *ERROR in the PID Block*
- 4 : R/L OUTPUT *OUTPUT in the RAISE/LOWER block*

RELAY SOURCE *SET/OUT OP31* *Range: Enumerated - see below*

The source of the relay output, terminals RL1A and RL1B. An internal link is made to one of the following parameters:

- 0 : NONE *No link is made*
- 1 : HEALTH *HEALTHY in the SEQ LOGIC block*
- 2 : TRIPPED *TRIPPED in the SEQ LOGIC block*
- 3 : RUNNING *RUNNING in the SEQ LOGIC block*
- 4 : AT ZERO *AT ZERO SPD in the ZERO SPEED block*
- 5 : AT SPEED *AT SPEED in the AT SPEED block*
- 6 : AT LOAD *AT OR ABOVE LOAD in the AT LOAD block*

DIGIO2 SOURCE *SET/OUT OP21* *Range: Enumerated - see below*

The source of the digital output 2, terminal 10. An internal link is made to one of the following parameters:

- 0 : NONE *No link is made*
- 1 : HEALTH *HEALTHY in the SEQ LOGIC block*
- 2 : TRIPPED *TRIPPED in the SEQ LOGIC block*
- 3 : RUNNING *RUNNING in the SEQ LOGIC block*
- 4 : AT ZERO *AT ZERO SPD in the ZERO SPEED block*
- 5 : AT SPEED *AT SPEED in the AT SPEED block*
- 6 : AT LOAD *AT OR ABOVE LOAD in the AT LOAD block*

APP LOCK *SET\SETP ST98* *Range: FALSE / TRUE*

Set this parameter to TRUE to prevent the APPLICATION parameter from being edited.

AT LOAD

This function block is used to generate the AT OR ABOVE LOAD signal that may be used as a digital output (refer to the APP CONFIG block).

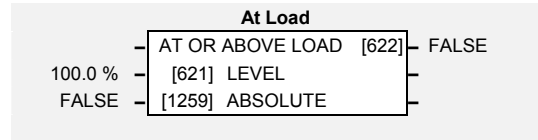

If operating as an open-loop drive (V/F fluxing) it is important to enter the no-load current at rated speed in to the MAG CURRENT parameter (S CL14 - MOTOR DATA function block), otherwise the LEVEL from this block could be inaccurate.

Parameter Descriptions

LEVEL

SET\SETP ST42

Range: -300.0 to 300.0 %

This parameter sets the value of load at which the AT OR ABOVE LOAD parameter becomes TRUE. 100% = rated torque for the motor.

ABSOLUTE

SET\SETP ST43

Range: FALSE / TRUE

When TRUE, the direction of rotation is ignored. In this case, the comparison level should always be positive.

When FALSE, the direction of rotation is not ignored. Driving a load in the reverse direction gives a negative value for torque. In this case, the comparison level may be positive or negative.

AT OR ABOVE LOAD

Range: FALSE / TRUE

This parameter is TRUE if the load is equal to or above the value set by the LEVEL parameter.

1-10 Programming Your Application

AT SPEED

This function block is used to generate the AT SPEED signal that may be used as a digital output (refer to the APP CONFIG block).

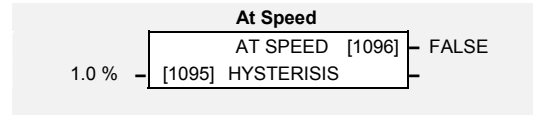

Parameter Descriptions

HYSTERESIS

Range: 0.0 to 300.0 %

Provides a hysteresis band about the Speed Setpoint in which the AT SPEED output is stable.

The Speed Setpoint is shown by the Speed Setpoint (%) diagnostic in the Diagnostics menu, which is shown as a percentage of the MAX SPEED parameter (Hz).

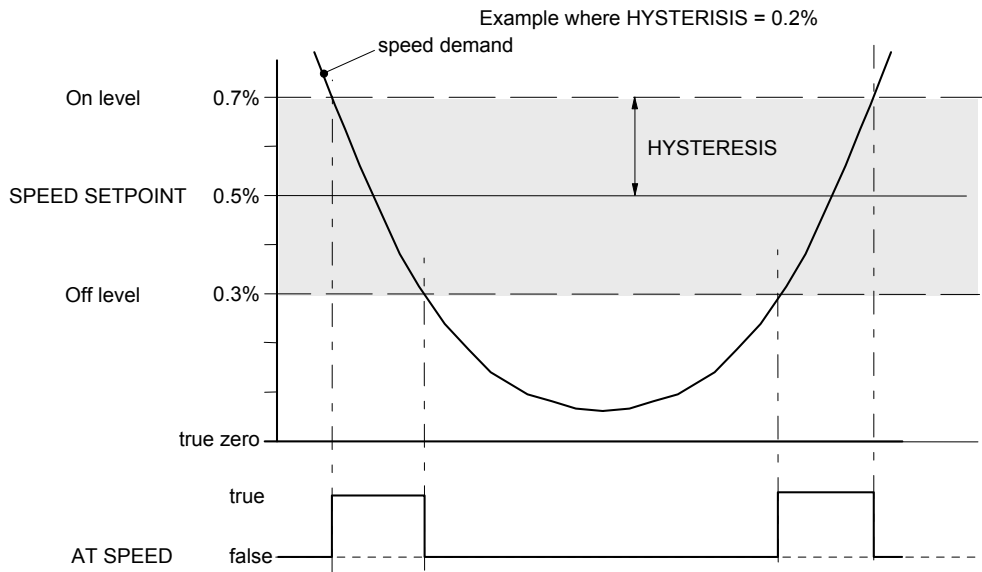

AT SPEED

Range: FALSE / TRUE

This parameter is TRUE when the speed demand is within the hysteresis band, as shown above, otherwise it is FALSE.

AUTO RESTART

Auto Restart (or Auto Reset) provides the facility to automatically reset a choice of trip events and restart the drive with a programmed number of attempts, after which, a manual or remote trip reset is required if the drive is not successfully restarted. The number of attempted restarts are recorded. This count is cleared after a trip-free period of operation (5 minutes or 4 x ATTEMPT DELAY 1, whichever is the longer), or after a successful manual or remote trip reset, or by removing the Run signal.

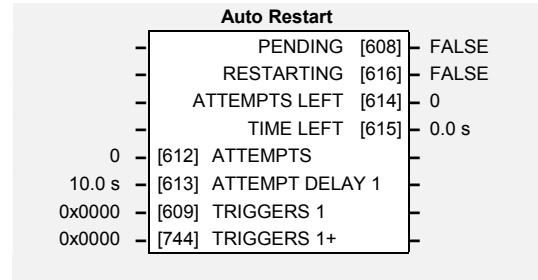

In addition, if the POWER UP START parameter in the SEQUENCING LOGIC function block is True, then the Auto Restart feature will also operate even if the trip initially occurs when the drive is not running (as long as the Run signal remains True).

Parameter Descriptions

ATTEMPTS *SET\SETP ST21* *Range: 1 to 10*
 Determines the number of restarts that will be permitted before requiring an external fault reset.

ATTEMPT DELAY 1 *SET\SETP ST22* *Range: 0.0 to 600.0 s*
 Determines the delay between restart attempts for a trip included in TRIGGERS 1. The delay is measured from all error conditions clearing.

TRIGGERS 1 and TRIGGERS+ 1 *SET\SETP ST23 and SET\SETP ST24* *Range: 0000 to FFFF*
 Allows Auto Restart to be enabled for a selection of trip conditions.

Refer to TRIPS STATUS, page 1-70 for an explanation of the four-digit codes.

PENDING *Range: FALSE / TRUE*
 Indicates that an auto restart will occur after the programmed delay.

RESTARTING *Range: FALSE / TRUE*
 Indicates that an auto restart is occurring. TRUE for a single block diagram execution cycle.

ATTEMPTS LEFT *Range: —.*
 Indicates the number of attempts left before an external fault reset is required.

TIME LEFT *Range: —.x s*
 When in the Restarting state, this parameter indicates the time left before an auto restart attempt will be permitted. When non-zero, this value is unaffected by changes to ATTEMPT DELAY 1.

1-12 Programming Your Application

AUTOTUNE

Designed for SENSORLESS VEC Motor Control Mode.

The Autotune is an automatic test sequence performed by the drive to identify motor model parameters. The motor model is used by the Sensorless Vector control mode. You **MUST** perform an Autotune before operating the drive in the Sensorless Vector control mode.

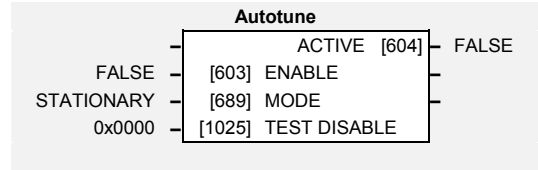

Refer to the Installation Product Manual, Chapter 4: “Operating the Drive” - Set-up using the Sensorless Vector Fluxing Mode.

Parameter Descriptions

ENABLE **SV** SET\CTRL CL21 *Range: FALSE / TRUE*

Determines whether the Autotune sequence is operational or not. The Autotune sequence is operational when set to TRUE and the drive is run. Refer to the Installation Product Manual, Chapter 4: “Operating the Drive” - The Autotune Feature.

MODE **SV** SET\CTRL CL20 *Range: Enumerated - see below*

Selects the Autotune operating mode. Refer to the Installation Product Manual, Chapter 4: “Operating the Drive” – The Autotune Feature.

Enumerated Value : MODE

- 0 : STATIONARY
- 1 : ROTATING

ACTIVE *Range: FALSE / TRUE*

This indicates the current state of the Autotune sequence. The Autotune sequence is operational when displaying TRUE.

TEST DISABLE *Range: 0000 to FFFF*

This allows individual Autotune tests to be disabled. The values corresponding to disabled tests are shown below.

Value	Disabled Tests
0000	None
0001	Stator Resistance
0002	Leakage Inductance
0003	Stator Resistance and Leakage Inductance
0004	Magnetising Current
0005	Stator Resistance and Magnetising Current
0006	Leakage Inductance and Magnetising Current
0007	All tests

Functional Description

The Autotune sequence identifies the following motor parameters:-

- Per-phase stator resistance (STATOR RES)
- Per-phase leakage inductance (LEAKAGE INDUC)
- Per-phase mutual inductance (MUTUAL INDUC)
- Rotor time constant (ROTOR TIME CONST)
- No-load magnetising line current (MAG CURRENT)

The Rotating Autotune sequence rotates the motor up to the user-programmed MAX SPEED (REFERENCE function block) in order to identify these parameters.

The Stationary Autotune sequence does not rotate the motor and requires the correct value of Magnetising Current to be entered.

The values of the above are stored in the MOTOR DATA function block. Autotune will overwrite any previous entry made for these parameters. Autotune can only be initiated from the “stopped” condition. When the test is complete, the stack is disabled and ENABLE is set to FALSE.

BRAKE CONTROL

This is used to control electro-mechanical motor brakes in hoist and lift applications.

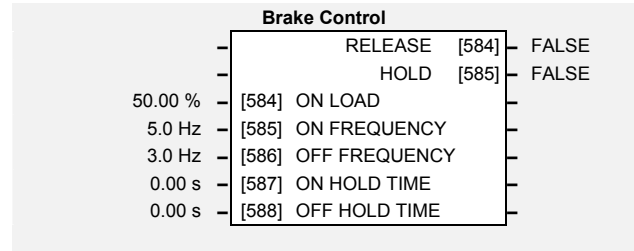

Parameter Descriptions

ON LOAD

Range: 0.00 to 150.00 %

Load level at which the external motor brake is released.

ON FREQUENCY

Range: 0.0 to 500.0 Hz

The output electrical frequency at which the external motor brake is released.

OFF FREQUENCY

Range: 0.0 to 500.0 Hz

The output electrical frequency at which the external motor brake is applied.

ON HOLD TIME

Range: 0.00 to 60.00 s

Sets the duration of the pulse output on HOLD when RELEASE becomes TRUE.

OFF HOLD TIME

Range: 0.00 to 60.00 s

Sets the duration of the pulse output on HOLD when RELEASE becomes FALSE.

RELEASE

Range: FALSE/ TRUE

Boolean output providing a signal to operate the brake delay. Note RELEASE is forced FALSE if the drive is not in Run mode, or if Autotune, Flycatching or Injection Braking are active.

HOLD

Range: FALSE / TRUE

Becomes TRUE when the brake is toggled On or Off by the function block, and remains TRUE for the duration set by OFF HOLD TIME or ON HOLD TIME.

Functional Description

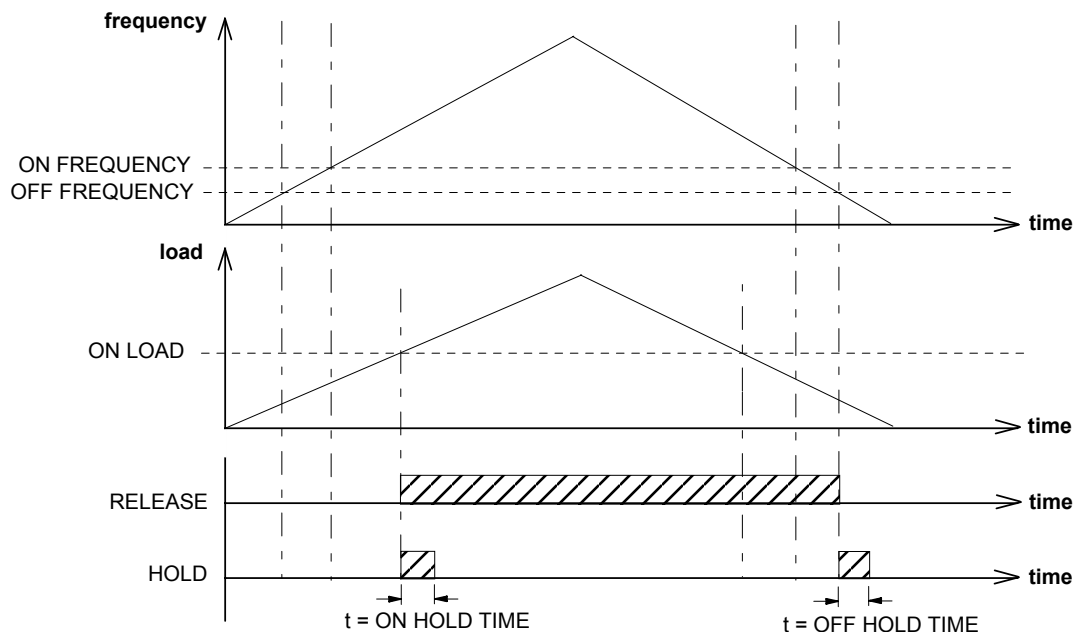

1-14 Programming Your Application

COMMS CONTROL

This block switches between Remote Terminal and Remote Comms operating modes.

The drive must be in Remote mode for selection to be made - REMOTE mode is enabled in the LOCAL CONTROL function block (REF MODES) and selected by the keypad. Refer to the outputs of the LOCAL CONTROL function block for the mode in use.

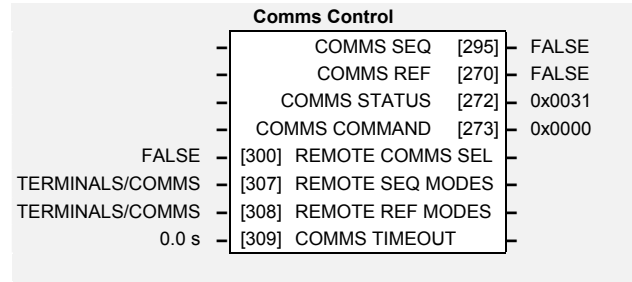

Parameter Descriptions

REMOTE COMMS SEL SET\SERL SE01 *Range: FALSE / TRUE*

Selects the type of remote communications mode:

0 : FALSE, and in REMOTE mode then control is from the terminals.

1 : TRUE, and in REMOTE mode then control is from the communications.

REMOTE SEQ MODES *Range: Enumerated - see below*

Selects the type of remote sequencing mode:

Enumerated Value : MODE

0 : TERMINALS/COMMS

1 : TERMINALS ONLY

2 : COMMS ONLY

REMOTE REF MODES *Range: Enumerated - see below*

Selects the type of remote reference mode:

Enumerated Value : MODE

0 : TERMINALS/COMMS

1 : TERMINALS ONLY

2 : COMMS ONLY

COMMS TIMEOUT SET\SERL SE02 *Range: 0.0 to 600.0 s*

Sets the maximum time allowed between refreshing the COMMS COMMAND parameter. The drive will trip if this time is exceeded. Set the time to 0.00 seconds to disable this feature.

COMMS SEQ *Range: FALSE / TRUE*

Diagnostic indicating if operating in Remote Sequencing Comms Mode.

If FALSE (0), the drive may be in Local Sequencing mode or Remote Sequencing Terminal mode.

COMMS REF *Range: FALSE / TRUE*

Diagnostic indicating if operating in Remote Reference Comms Mode.

If FALSE (0), the drive may be in Local Reference mode or Remote Reference Terminal mode.

COMMS STATUS *Range: 0000 to FFFF*

Diagnostic showing the 16-bit Status word as seen by the communications.

Refer to Chapter 4: "Sequencing Logic".

COMMS COMMAND *Range: 0000 to FFFF*

Diagnostic showing the 16-bit Command as written by the communications.

Refer to Chapter 4: "Sequencing Logic".

COMMS PORTS

This function block configures the programming ports that allow connection to the keypad, or to a personal computer.

The parameters below are used to identify the drive to the controlling software for drive configuration and storage of parameters.

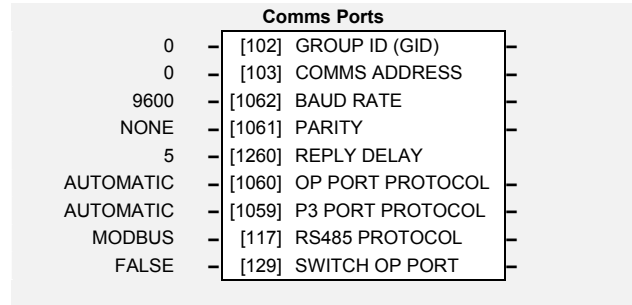

Parameter Descriptions

GROUP ID (GID)

Range: 0 to 7

The Parker SSD Drives protocol group identity address.

COMMS ADDRESS

F SET\SERL SE03

Range: 0 to 255

The Parker SSD Drives protocol unit identity address or the Modbus node address.
 Note: if set to 0, it will only respond to broadcast messages.

BAUD RATE

F SET\SERL SE04

Range: Enumerated - see below

Selects the Baud Rate for the MODBUS protocol.

Enumerated Value : BAUD RATE

- 0 : 1200
- 1 : 2400
- 2 : 4800
- 3 : 7200
- 4 : 9600
- 5 : 14400
- 6 : 19200
- 7 : 38400
- 8 : 57600

PARITY

F SET\SERL SE05

Range: Enumerated - see below

Selects the Parity for the MODBUS protocol.

Enumerated Value : PARITY

- 0 : NONE
- 1 : ODD
- 2 : EVEN

REPLY DELAY

F SET\SERL SE06

Range: 0 to 200

The time in milliseconds between the drive receiving the complete request from the communications master (PLC/PC) and replying to this request.

OP PORT PROTOCOL

F SET\SERL SE07

Range: Enumerated - see below

Selects the protocol to be used by the keypad port on the front of the drive. When EIBISYNC ASCII is selected, BAUD RATE is 19200 and PARITY is EVEN.

Enumerated Value : PROTOCOL

- 0 : AUTOMATIC - checks for keypad or EI ASCII
- 1 : KEYPAD
- 2 : EIBISYNC ASCII
- 3 : MODBUS
- 4 : FIELDBUS (reserved for future use)

1-16 Programming Your Application

P3 PORT PROTOCOL  *SET\SERL SE08* *Range: Enumerated - see below*

Selects the protocol to be used by the RS232 programming port on the drive's control board. When EIBISYNC ASCII is selected, BAUD RATE is 19200 and PARITY is EVEN.

Enumerated Value : PROTOCOL

- 0 : AUTOMATIC - checks for keypad or EI ASCII
- 1 : KEYPAD
- 2 : EIBISYNC ASCII
- 3 : MODBUS
- 4 : FIELDBUS (reserved for future use)

RS485 PROTOCOL  *SET\SERL SE09* *Range: Enumerated - see below*

This parameter is not available on the 650G Frame 1, 2 & 3.

Selects the protocol to be used by the RS485 programming port on the drive's control board.

Enumerated Value : PROTOCOL

- 0 : AUTOMATIC
- 1 : KEYPAD (not applicable)
- 2 : EIBISYNC ASCII
- 3 : MODBUS
- 4 : FIELDBUS (reserved for future use)

SWITCH OP PORT  *SET\SERL SE10* *Range: FALSE / TRUE*

This parameter is not available on the 650G Frame 1, 2 & 3.

When TRUE, the keypad port on the front of the drive is disabled when the communications equipment is connected to the RS232 programming port on the drive's control board.

When FALSE, the RS485 programming port is disabled when the communications equipment is connected to the RS232 programming port. Both ports are on the drive's control board.

Functional Description

When communicating using the EI BISOYNC ASCII protocol, the unit will always respond to GID = 0 and UID = 0, as this is the broadcast address used by the 6901 keypad.

CURRENT LIMIT

Designed for all Motor Control Modes.

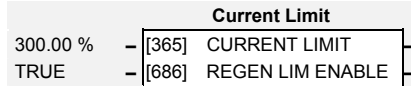

This function block allows you to set the maximum level of motor rated current (as a % of the user-set MOTOR CURRENT) which is allowed to flow before current limit action occurs. If the measured motor current exceeds the current limit value with a motoring load, the motor speed is reduced to shed the excess load. If the measured motor current exceeds the current limit value with a regenerating load, the motor speed is increased up to a maximum of MAX SPEED (REFERENCE function block).

Note: *The maximum value of CURRENT LIMIT for a particular motor is limited by the 650G current rating. If a motor of larger rating than the 650G is connected to the drive, then the current limit applies to the 650G and not the motor. In this case the maximum value of the current limit parameter is 150.00%*

Parameter Descriptions

CURRENT LIMIT  **SV** SET\CTRL CL81 *Range: 0.00 to 300.00 %*

This parameter sets the level of motor current, as a % of MOTOR CURRENT (refer to the MOTOR DATA function block) at which the drive begins to take current limit action.

Refer also to “Normal/Heavy Duty Selection”, page 1-82.

REGEN LIM ENABLE *Range: FALSE / TRUE*

This parameter enables or disables regenerative current limit action.

Note that this parameter only works in open-loop VOLTS / Hz motor control mode.

1-18 Programming Your Application

CUSTOM MENU

This function block is used to create a Custom Menu.

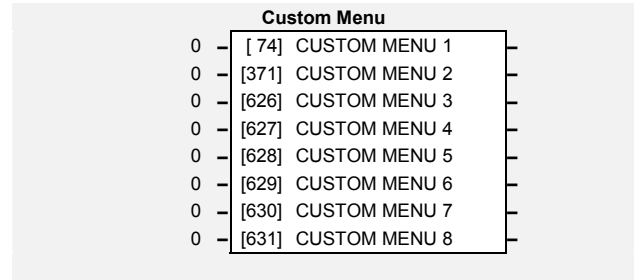

Parameter Descriptions

CUSTOM MENU 1 to 8

Range: 0 to 1655

Select a parameter to be displayed in the PAR Menu by entering the Tag Number for the parameter. Eight parameters can be entered into the menu. CUSTOM MENU 1 is the first of the new parameters in the menu, CUSTOM MENU 2 is the second of the new parameters in the menu, and so on. These parameters contained in P⁹⁰¹ to P⁹⁰⁸ will appear at the bottom of the parameter list for the PAR Menu.

Enter 0 to leave a position in the menu unused.

DEMULTIPLEXER

The demultiplexer function block splits the input word into 16 individual bits.

This may be used to extract the individual trip bits from the ACTIVE TRIPS parameter, for example.

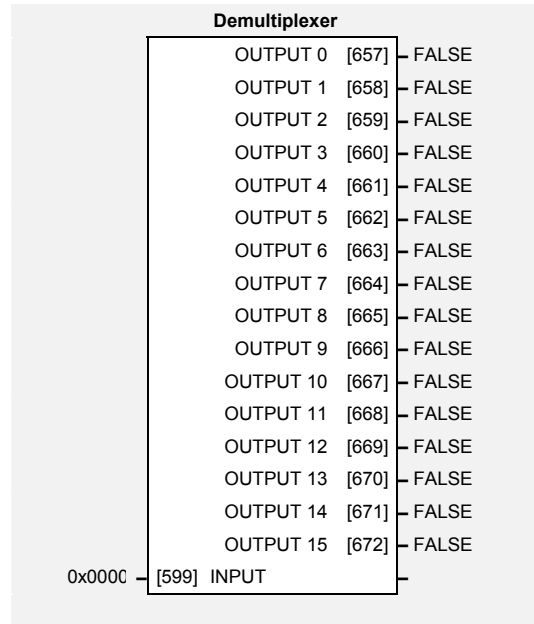

Parameter Descriptions

INPUT

The input to be split into its component bits.

Range: 0000 to FFFF

OUTPUT 0 TO OUTPUT 15

Each output returns the corresponding bit of the 16 bit input word.

Range: FALSE / TRUE

1-20 Programming Your Application

DIGITAL INPUT

The digital input block converts the physical input voltage to TRUE or FALSE control signals.

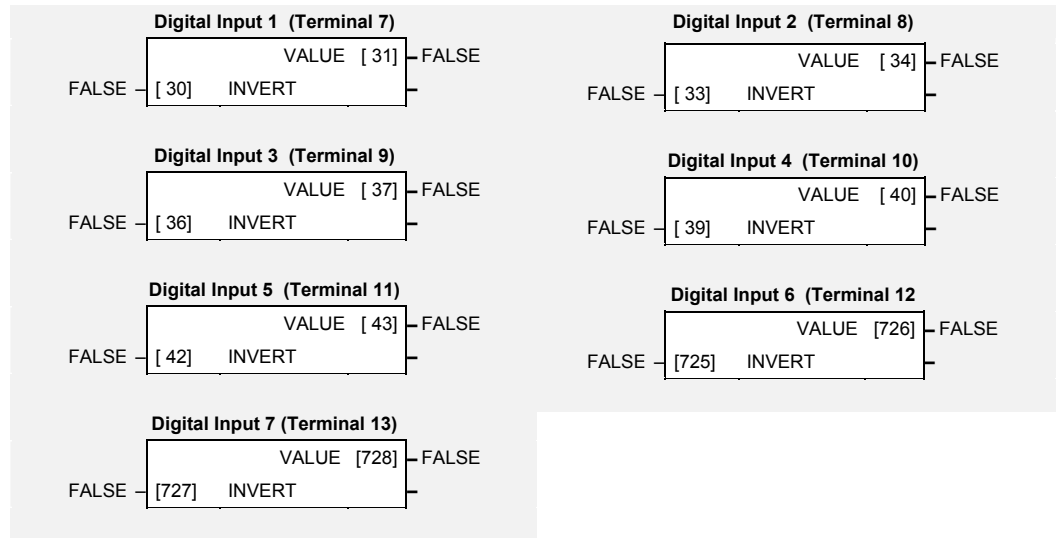

Functional Description

There is a DIGITAL INPUT function block associated with each of the following terminals:

The Control Board has seven configurable digital inputs:

- DIGITAL INPUT 1 is associated with terminal 7
- DIGITAL INPUT 2 is associated with terminal 8
- DIGITAL INPUT 3 is associated with terminal 9 (shares terminal with DOUT1)
- DIGITAL INPUT 4 is associated with terminal 10 (shares terminal with DOUT2)
- DIGITAL INPUT 5 is associated with terminal 11
- DIGITAL INPUT 6 is associated with terminal 12
- DIGITAL INPUT 7 is associated with terminal 13

Parameter Descriptions

INVERT *SET/IN IP01 to IP07* *Range: FALSE / TRUE*

Controls the optional inversion of the VALUE output.

VALUE *SET/IN IPD1 to IPD7* *Range: FALSE / TRUE*

The TRUE or FALSE input, (after any inversion).

DIGITAL OUTPUT

The digital output block converts a logic TRUE or FALSE demand to a physical output signal.

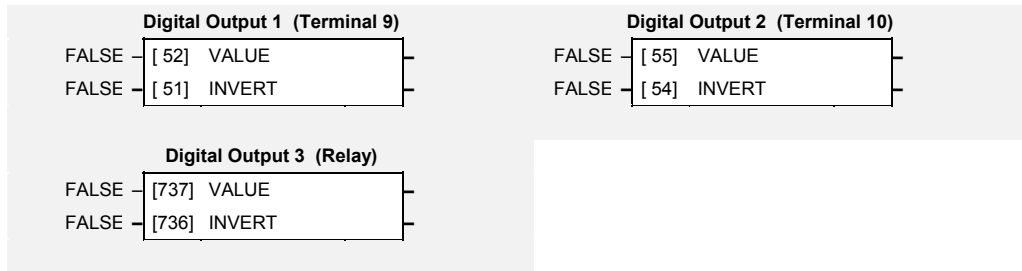

Parameter Descriptions

VALUE *SET/OUT OP23 - DOUT2* *Range: FALSE / TRUE*
SET/OUT OP33 - DOUT3

The TRUE or FALSE output demand.

INVERT *SET/OUT OP22 - DOUT2* *Range: FALSE / TRUE*
SET/OUT OP32 - DOUT3

Controls the optional inversion of the VALUE output.

Functional Description

There is a DIGITAL OUTPUT function block associated with each of the following terminals:

The Control Board has three digital outputs (volt-free relay contacts):

- DIGITAL OUTPUT 1 is associated with terminals 9 (shares terminal with DIN3)
- DIGITAL OUTPUT 2 is associated with terminals 10 (shares terminal with DIN4)
- DIGITAL OUTPUT 3 is associated with terminals RL1A and RL1B (user relay)

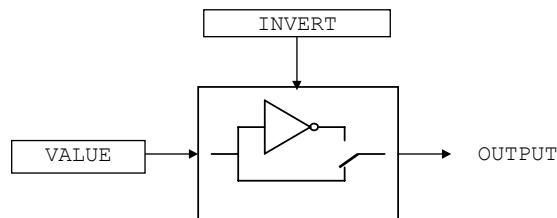

1-22 Programming Your Application

DISPLAY/KEYPAD

This function block provides information about the keypad connected to the drive and can be used to customise the keypad control keys.

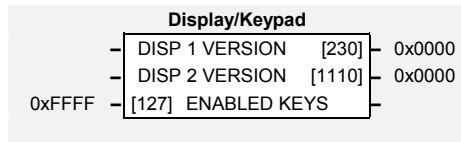

Parameter Descriptions

ENABLED KEYS SET\SETP ST52 Range: 0000 to FFFF

The following keys on the 6901 keypad can be enabled or disabled separately. The combination produces the parameter setting as in the table below. The default of 0xFFFF enables all keys.



6901

Parameter Setting	RUN	L/R	JOG	DIR
0000	-	-	-	-
0010	-	-	-	ENABLED
0020	-	-	ENABLED	-
0030	-	-	ENABLED	ENABLED
0040	-	ENABLED	-	-
0050	-	ENABLED	-	ENABLED
0060	-	ENABLED	ENABLED	-
0070	-	ENABLED	ENABLED	ENABLED
0080	ENABLED	-	-	-
0090	ENABLED	-	-	ENABLED
00A0	ENABLED	-	ENABLED	-
00B0	ENABLED	-	ENABLED	ENABLED
00C0	ENABLED	ENABLED	-	-
00D0	ENABLED	ENABLED	-	ENABLED
00E0	ENABLED	ENABLED	ENABLED	-
00F0	ENABLED	ENABLED	ENABLED	ENABLED



6511



6521

When using the standard 6511 and 6521 keypad, disabling the **DIR** key prevents the local setpoint going negative (for reverse). Similarly, disabling the **L/R** key prevents the drive being changed from Local to Remote, or Remote to Local modes.

DISP 1 VERSION Range: 0000 to FFFF

This is the software version of the keypad connected to the keypad port on the front of the drive.

DISP 2 VERSION Range: 0000 to FFFF

This is the software version of the keypad connected to the RS232 programming port. This port is located on the control board inside the drive.

DYNAMIC BRAKING

Designed for all Motor Control Modes.

The dynamic braking function block controls the rate at which energy from a regenerating motor is dumped into a resistive load. This dumping prevents the dc link voltage reaching levels which would cause an Overvoltage trip.

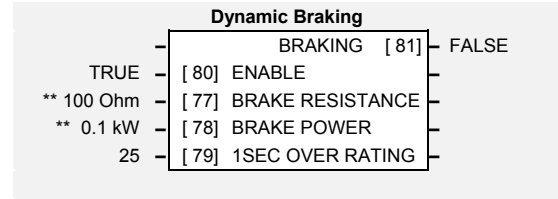

Parameter Descriptions

- | | | |
|--------------------------------------------------------------------------------------------------|----------------------|-------------------------------|
| ENABLE | <i>SET\SETP ST31</i> | <i>Range: FALSE / TRUE</i> |
| Enables operation of the dynamic braking block. | | |
| BRAKE RESISTANCE | <i>SET\SETP ST32</i> | <i>Range: 1 to 1000 Ohm</i> |
| The value of the load resistance. | | |
| BRAKE POWER | <i>SET\SETP ST33</i> | <i>Range: 0.1 to 510.0 kW</i> |
| The power that the load resistance may continually dissipate. | | |
| 1SEC OVER RATING | <i>SET\SETP ST34</i> | <i>Range: 1 to 40</i> |
| Multiplier that may be applied to BRAKE POWER for power overloads lasting no more than 1 second. | | |
| BRAKING | | <i>Range: FALSE / TRUE</i> |
| A read-only parameter indicating the state of the brake switch. | | |

Functional Description

When enabled, the DYNAMIC BRAKING block monitors the internal dc link voltage every milli-second and sets the state of the brake switch accordingly.

The dynamic braking block provides a control signal that is used by the SLEW RATE LIMIT block. This causes the setpoint to be temporarily frozen whenever the dynamic brake is operating because the dc link voltage exceeds the internal comparison level. This allows the stop rate to be automatically tuned to the characteristics of the load, motor, drive and brake resistor.

The DYNAMIC BRAKING block operates even when the motor output is not enabled. This allows the block to continually monitor the energy dumped into the braking resistor, and the energy dissipated across the brake switch. With this information the drive is able to deduce the loading on the brake resistor. Optional trips may be enabled should the switch or resistor be loaded beyond its capabilities.

Refer also to the Installation Product Manual, Chapter 12: “Application Notes” - Dynamic Braking.

1-24 Programming Your Application

ENCODER

The ENCODER block allows Speed Feedback to be measured. Simple position measuring is also provided, but is limited to a 16-bit range.

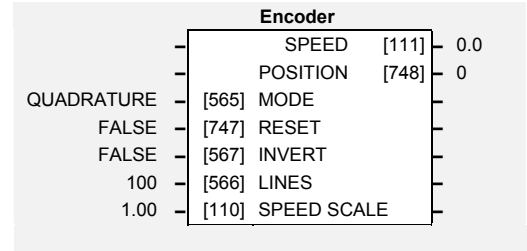

Parameter Descriptions

MODE *SET\ENC EN01* *Range: Enumerated - see below*

Set this parameter to the requirements for your encoder.

Enumerated Value : MODE

- 0 : QUADRATURE (using digital inputs 6 & 7, ENCA and ENCB respectively)
- 1 : CLOCK/DIR (using digital inputs 6 & 7, ENCA and ENCB respectively)
- 2 : CLOCK (using digital input 6, ENCA)

RESET *SET\ENC EN02* *Range: FALSE / TRUE*

When TRUE the POSITION and SPEED outputs are set (and held) at zero.

INVERT *SET\ENC EN03* *Range: FALSE / TRUE*

When TRUE, changes the sign of the measured speed and the direction of the position count.

LINES *SET\ENC EN04* *Range: 100 to 10000*

The number of lines must be set to match the type of encoder being used. Incorrect setting of this parameter will result in an erroneous speed measurement.

SPEED SCALE *SET\ENC EN05* *Range: 0.00 to 300.00*

This parameter allows the output "speed" to be scaled to any value the user requires. With a default value of 1.00, the output "speed" is measured in revs per second. Changing the SPEED SCALE value to 60.00 will provide an output in revs per minute.

To provide an output in percent of the motor maximum speed, where maximum speed is the maximum speed your motor will run in rpm, the SPEED SCALE parameter should be set to the result of:

$$\frac{6000}{\text{maximum speed (rpm)}}$$

SPEED *SET\ENC EN06* *Range: xxx.x*

Speed feedback, in units defined by the SPEED SCALE parameter.

POSITION *Range: xxxx*

Number of encoder "counts" from when RESET was set to FALSE. The value will increment or decrement depending on the direction the encoder is rotated. The value will "wrap around" between 32767 and -32768.

Functional Description

A quadrature encoder uses 2 input signals (A and B), phase shifted by a quarter of a cycle (90°). Direction is obtained by looking at the combined state of A and B.

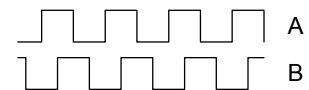

Speed is calculated using the following function:

$$\text{SPEED HZ} = \text{filter} \left[\frac{\text{CountsPerSecond}}{\text{Lines} \times 4}, \text{FilterTime} \right]$$

where counts per second are the number of edges received from the encoder. There are 4 counts per line.

ENERGY METER

This block measures the energy used by the load.

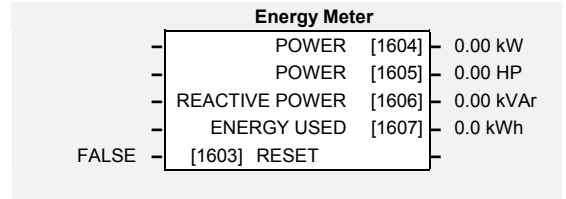

Parameter Descriptions

RESET

Range: FALSE / TRUE

When RESET is set to TRUE, the ENERGY USED parameter is reset to zero automatically when the maximum value is reached.

When RESET is set to FALSE, the ENERGY USED parameter is held at the maximum value when the maximum value has been reached

Changing this from FALSE to TRUE at anytime will cause the ENERGY USED parameter to be reset to zero.

POWER

Range: -32768.00 to 32767.00 kW

This diagnostic shows the power being delivered to the load in kilowatts.

POWER

Range: -32768.00 to 32767.00 HP

This diagnostic shows the power being delivered to the load in horsepower.

REACTIVE POWER

*Range: -32768.00 to 32767.00
kVAr*

This diagnostic shows the reactive power being delivered to the load in kilovolt-amperes reactive.

ENERGY USED

Range: 0.00 to 32767.00 kWh

This diagnostic shows the total energy consumed by the load in kilowatt hours.

1-26 Programming Your Application

FEEDBACKS

Designed for all Motor Control Modes.

The FEEDBACKS block allows you to view speed feedback and motor current related diagnostics.

Feedbacks		
-	DC LINK VOLTS	[75] 700 V
-	MOTOR CURRENT %	[66] 0.0 %
-	MOTOR CURRENT A	[67] 0.0 A
-	TERMINAL VOLTS	[1020] 0 V
-	SPEED FBK RPM	[569] 0.00 RPM
-	SPEED FBK REV/S	[568] 0.00
-	SPEED FBK %	[749] 0.00 %
-	TORQUE FEEDBACK	[70] 0.00 %
-	FIELD FEEDBACK	[73] 0.00 %
FALSE -	[50] NORMAL DUTY	

Parameter Descriptions

NORMAL DUTY was previously referred to as Quadratic Torque in past Drives' manuals.

NORMAL DUTY

PAR\ P12

Range: FALSE/TRUE

When TRUE, selects NORMAL DUTY allowing higher continuous ratings with less overload capability. This is especially suited to fan or pump applications.

When FALSE, selects HEAVY DUTY.

DC LINK VOLTS

DIAG 3

Range: —, V

This diagnostic shows the voltage on the dc link capacitors.

MOTOR CURRENT %

Range: —.xx %

Contains the level of rms line current being drawn from the drive and is seen as a % of the MOTOR CURRENT parameter setting in the MOTOR DATA function block.

MOTOR CURRENT A

DIAG 4

Range: —.xx A

This diagnostic contains the level of rms line current being drawn from the drive.

SPEED FBK REV/S

Range: —.xx

This parameter changes according to the CONTROL MODE (MOTOR DATA function block):

- In SENSORLESS VEC mode the parameter shows the calculated mechanical speed of the motor shaft in revolutions per second.
- In VOLTS / Hz mode, the parameter shows the motor synchronous speed in revolutions per second.

SPEED FBK %

Range: —.xx %

This parameter changes according to the CONTROL MODE (MOTOR DATA function block):

- In SENSORLESS VEC mode the parameter shows the calculated mechanical speed of the motor shaft as a percentage of the user maximum speed setting (MAX SPEED in the REFERENCE function block).
- In VOLTS / Hz mode, the parameter shows the electrical drive output frequency as a percentage of the user maximum speed setting (MAX SPEED in the REFERENCE function block).

TORQUE FEEDBACK

SET\SETP ST41

Range: —.xx %

Shows the estimated motor torque, as a percentage of rated motor torque.

FIELD FEEDBACK

Range: —.xx %

A value of 100% indicates the motor is operating at rated magnetic flux (field).

1-28 Programming Your Application

FLUXING

Designed for VOLTS/Hz motor Control Mode.

This function block allows user parameterisation of the conventional (volts/hertz) fluxing strategy of the drive. This is achieved through two flexible Volts-to-frequency templates. Starting torque performance can also be tailored through the FIXED BOOST and AUTO BOOST parameters.

Fluxing	
LINEAR LAW	[104] V/F SHAPE
** 0.00 %	[107] FIXED BOOST
0.00 %	[108] AUTO BOOST
** FALSE	[1058] 601 FLUXING
FALSE	[1655] ENERGY SAVING

Parameter Descriptions

V/F SHAPE

PAR\ P11

Range: Enumerated - see below

This parameter determines the type of volts to frequency template is used to flux the motor. The choices of this parameter are:

Enumerated Value : V/F SHAPE

- 0 : LINEAR LAW
- 1 : FAN LAW

LINEAR LAW : This gives a constant flux characteristic up to the BASE FREQUENCY
 FAN LAW: This gives a quadratic flux characteristic up to the BASE FREQUENCY. This matches the load requirement for fan and most pump applications

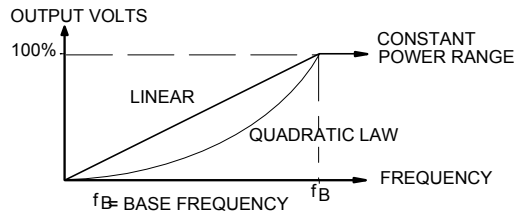

FIXED BOOST

M V/F PAR\ P13

Range: 0.00 to 25.00 %

This parameter allows for no-load stator resistance voltage drop compensation. This correctly fluxes the motor (under no-load conditions) at low output frequencies, thereby increasing available motor torque. Fixed boost can be set in addition to auto boost.

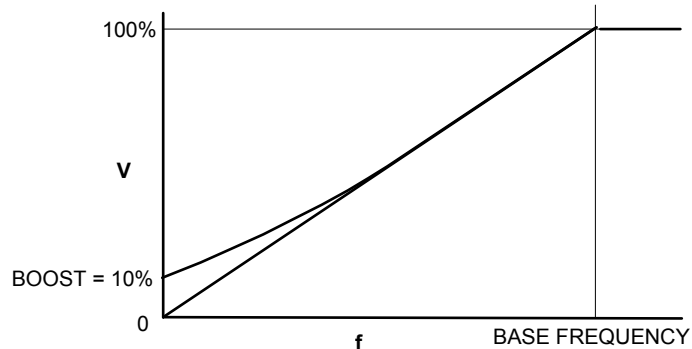

AUTO BOOST

F M VF SET\CTRL CL08 Range: 0.00 to 25.00 %

This parameter allows for load dependent stator resistance voltage drop compensation. This correctly fluxes the motor (under load conditions) at low output frequencies, thereby increasing available motor torque. Auto boost can be set in addition to fixed boost.

The value of the AUTO BOOST parameter determines level of additional volts supplied to the motor for 100% load.

Setting the value of auto boost too high can cause the drive to enter current limit. If this occurs, the drive will be unable to ramp up in speed. Reducing the value of auto boost will eliminate this problem.

601 FLUXING (BOOST MODE)

F M VF SET\CTRL CL07 Range: FALSE / TRUE

Determines the relationship between fixed boost and terminal volts. There are two settings:

FALSE produces the terminal volts profile shown below (with Auto Boost, CL08, set to 0.0 %). In this mode AUTO BOOST (CL08) should be set to provide optimum low speed performance.

TRUE emulates the terminal volts profile provided by the Parker SSD Drives' 601 product. This allows drop in replacement of the 601 by the 650G. AUTO BOOST (CL08) has no effect in this mode.

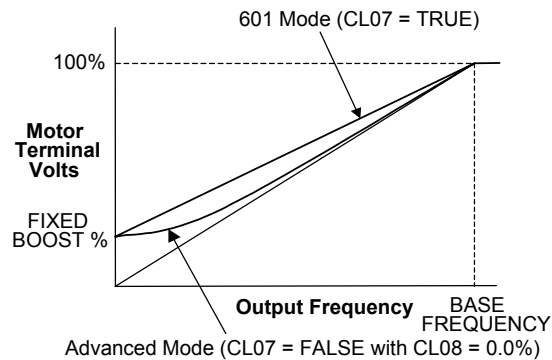

ENERGY SAVING

F M VF SET\CTRL CL09 Range: FALSE / TRUE

When set TRUE, the demanded volts are reduced to minimise energy consumption if the drive is operating in a steady state at light load.

1-30 Programming Your Application

Functional Description

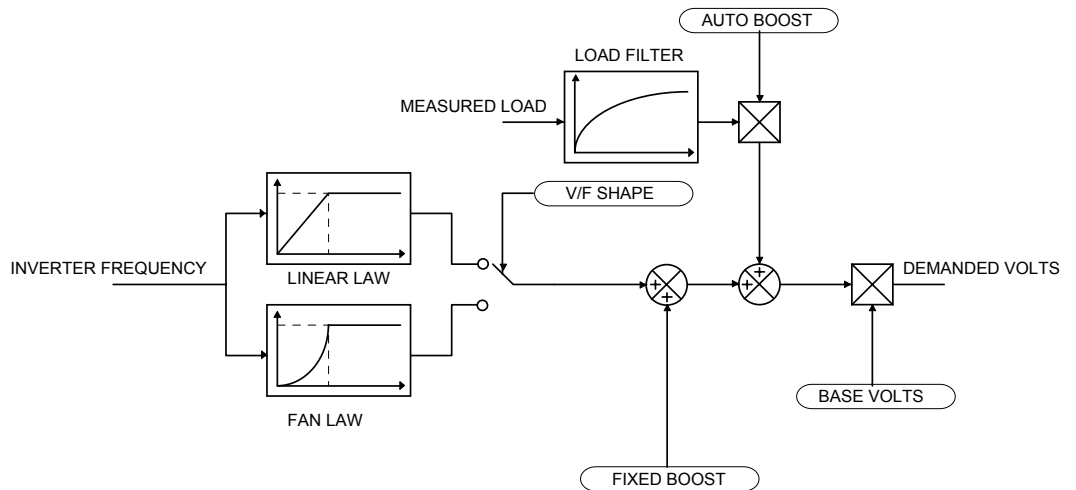

The function block allows the user to parameterise the drive's conventional V/F motor fluxing scheme. Two V/F shapes are available, LINEAR LAW and FAN LAW:

- Linear Law V/F shape should be used in applications requiring constant motor torque though out the speed range (e.g. machine tools or hoists).
- Fan Law V/F shape provides extra energy savings for fan or pump applications.

Correct no-load motor fluxing at low drive output frequencies can be achieved by setting the FIXED BOOST parameter.

Correct motor fluxing under load conditions is achieved by setting the AUTO BOOST parameter.

The motor is correctly fluxed when the FIELD FEEDBACK diagnostic in the FEEDBACKS function block reads 100.0% .

FLYCATCHING

Designed for all Motor Control Modes.

This block performs a directional speed search. It allows the drive to seamlessly catch a spinning motor before controlling the motor to the desired setpoint.

This is especially useful for large inertia fan loads, where drafts in building air ducts can cause a fan to 'windmill'.

Flycatching			
	ACTIVE	[576]	FALSE
	SETPOINT	[28]	0.00 %
FALSE	[570]	VHZ ENABLE	
TRUE	[1553]	VECTOR ENABLE	
ALWAYS	[571]	START MODE	
BIDIRECTIONAL	[572]	SEARCH MODE	
** 9.00 %	[573]	SEARCH VOLTS	
** 40.00 %	[32]	SEARCH BOOST	
** 10.0 s	[574]	SEARCH TIME	
5.0 Hz	[575]	MIN SEARCH SPEED	
** 3.0 s	[709]	REFLUX TIME	

Parameter Descriptions

VHz ENABLE  *SET\CTRL CL03* *Range: FALSE / TRUE*

Enables flycatching in Volts/Hz control mode when TRUE.

VECTOR ENABLE  *SET\CTRL CL03* *Range: FALSE / TRUE*

Enables flycatching in Sensorless Vector control mode when TRUE.

START MODE *Range: Enumerated - see below*

The mode of operation for the flycatching sequence software.

Enumerated Value : START MODE

- 0 : ALWAYS
- 1 : TRIP OR POWERUP
- 2 : TRIP

SEARCH MODE *Range: Enumerated - see below*

The type of speed search carried out by the flycatching sequence.

Enumerated Value : SEARCH MODE

- 0 : BIDIRECTIONAL
- 1 : UNIDIRECTIONAL

SEARCH VOLTS *Range: 0.00 to 100.00 %*

The percentage level of the search volts applied to the motor during the speed search phase of the flycatching sequence. Increasing this parameter improves the accuracy of the discovered motor speed but increases the braking influence of the speed search on the rotating motor.

SEARCH BOOST *Range: 0.00 to 50.00 %*

The level of search boost applied to the motor during the speed search phase of the flycatching sequence.

SEARCH TIME *Range: 0.1 to 60.0 s*

The search rate during the speed search phase of the flycatching sequence. Performing the flycatching speed search too quickly can cause the drive to inaccurately identify the motor speed. Refluxing at an inaccurate motor speed can cause the drive to trip on overvoltage. If this occurs, increasing this parameter will reduce the risk of tripping.

MIN SEARCH SPEED *Range: 0.0 to 500.0 Hz*

The lowest search speed before the speed search phase of the flycatching sequence is considered to have failed.

REFLUX TIME *Range: 0.1 to 20.0 s*

The rate of rise of volts from the search level to the working level after a successful speed search. Refluxing the motor too quickly can cause the drive to trip on either overvoltage or overcurrent. In either case, increasing this parameter will reduce the risk of tripping.

1-32 Programming Your Application

ACTIVE

Range: FALSE / TRUE

A diagnostic output indicating whether the flycatching sequence is active.

SETPOINT

Range xxx.xx %

This output is the setpoint caught at the end of a successful flycatching sequence.

Functional Description

The flycatching function enables the drive to be restarted smoothly into a spinning motor. It applies small search voltages to the motor whilst ramping the drive frequency from maximum speed (MAX SPEED in the REFERENCE function block) to zero. When the motor load goes from motoring to regenerating, the speed search has succeeded and is terminated.

The type of speed sequence may be Unidirectional or Bidirectional. The examples below assume a “positive” setpoint. (A “negative” setpoint would alter the signs for MAX SPEED and MIN SEARCH SPEED in the examples).

Unidirectional

The search is performed only in the direction of the speed setpoint:

The drive starts the search at +110% of MAX SPEED. It then searches to the MIN SEARCH SPEED (for example +5Hz), towards zero.

If the speed is not found, the drive will ramp to the speed setpoint from zero, as normal.

Bidirectional

Initially, the search is performed in the direction of the speed setpoint:

The drive starts the search at +110% of MAX SPEED. It then searches to the MIN SEARCH SPEED (for example +5Hz), towards zero.

If the speed is not found in this direction, a second speed search is performed in the opposite direction:

The drive starts the search at -110% of MAX SPEED. It then searches to the MIN SEARCH SPEED (for example -5Hz), towards zero.

If the speed is not found, the drive will ramp to the speed setpoint from zero, as normal.

The flycatching sequence can be triggered by different starting conditions:

ALWAYS:	All starts (after controlled or uncontrolled stop, or after a power-up)
TRIP or POWER-UP:	After uncontrolled stop, i.e. trip or coast, or after a power-up
TRIP:	After uncontrolled stop, i.e. trip or coast

INJ BRAKING

Designed for VOLTS/Hz Motor Control Mode.

The injection braking block provides a method of stopping spinning induction motors without returning the kinetic energy of the motor and load back in to the dc link of the drive. This is achieved by running the motor highly inefficiently so that all the energy stored in the load is dissipated in the motor. Thus, high inertia loads can be stopped without the need for an external dynamic braking resistor.

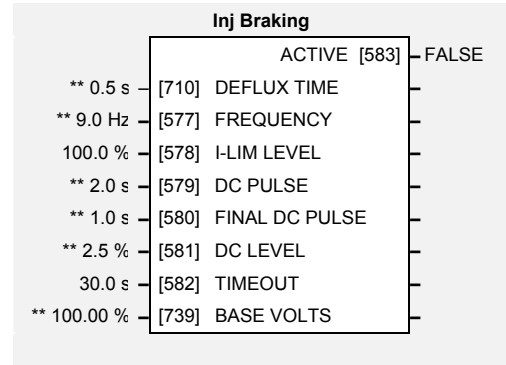

Parameter Descriptions

DEFLUX TIME

Range: 0.1 to 20.0 s

Determines the time in which the drive defluxes the motor prior injection braking.

FREQUENCY

Range: 1.0 to 240.0 Hz

Determines the maximum frequency applied to the motor for the low frequency injection braking mode. It is also clamped internally so as never to exceed 50% of base speed value.

I-LIM LEVEL

Range: 50.0 to 150.0 %

Determines the level of motor current flowing during low frequency injection braking.

DC PULSE

Range: 0.0 to 100.0 s

Determines the duration of the dc pulse applied to the motor when injection braking is required for motor speeds below 20% of base speed. The actual dc pulse time applied to the motor is dependent on the ratio of initial motor speed to 20% of base speed.

FINAL DC PULSE

Range: 0.0 to 10.0 s

Determines the duration of the final dc holding pulse applied to the motor after either low frequency injection braking or timed dc pulse.

DC LEVEL

Range: 0.0 to 25.0 %

Determines the level of dc pulse applied to the motor during either the timed or final dc pulse.

TIMEOUT

Range: 0.0 to 600.0 s

Determines the maximum amount of time the sequence is allowed to remain in the low frequency injection braking state.

BASE VOLTS

Range: 0.00 to 115.47 %

Determines the maximum volts at base speed applied to the motor during injection braking.

ACTIVE

Range: FALSE / TRUE

Indicates the state of the drive. TRUE when injection braking.

1-34 Programming Your Application

INVERSE TIME

Designed for all Motor Control Modes.

The purpose of the inverse time is to automatically reduce the drive current limit in response to prolonged overload conditions. As the motor current exceeds the AIMING POINT level, the excess current is integrated. Motor current is allowed to flow at the CURRENT LIMIT (see the CURRENT LIMIT function block) for a period defined by the DELAY parameter. At this point the inverse time current limit is ramped down from 150.0 % to the level defined by AIMING POINT. The rate at which the inverse time current limit is ramped to the AIMING POINT is defined by DOWN TIME.

Once the overload condition is removed, the inverse time current limit level is ramped back toward the CURRENT LIMIT level at a rate defined by UP TIME.

In Normal Duty torque mode, the allowed overload is reduced to 115.0 % for 60.0 s before inverse time current limit action occurs.

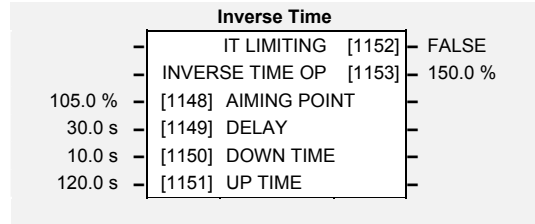

Parameter Descriptions

AIMING POINT

Range: 50.0 to 150.0%

Determines the final level of the inverse time current limit after a period of prolonged motor overload

DELAY

Range: 5.0 to 60.0s

Determines the maximum allowed overload duration for 150.0 % motor current (110.0% in QUADRATIC TORQUE mode) before inverse time current limit action is taken.

Refer also to “Normal/Heavy Duty Selection”, page 1-82.

DOWN TIME

Range: 1.0 to 10.0s

Determines the rate at which the inverse time current limit is ramped to the AIMING POINT after a period of prolonged overload.

UP TIME

Range: 1.0 to 600.0s

Determines the rate at which the inverse time current limit is ramped back to the CURRENT LIMIT once the overload is removed.

IT LIMITING

Range: FALSE / TRUE

This indicates if the inverse time current limit is active.

INVERSE TIME OP

Range: —.x %

This indicates the present level of the inverse time current limit.

I/O TRIPS

This function block is designed to operate in conjunction with the Digital Input function blocks to trip the drive on a loss of safety control input.

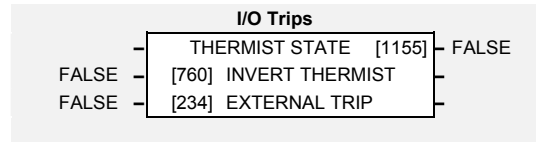

Parameter Descriptions

INVERT THERMIST

Range: FALSE / TRUE

Inverts the sense of the motor thermistor input. The default FALSE is normally-closed/low impedance.

EXTERNAL TRIP

Range: FALSE / TRUE

When this input is set TRUE the drive will trip on EXTERNAL TRIP. This input may be connected to one of the digital inputs to provide a high priority coast to stop that also sets the TRIPPED output high.

THERMIST STATE

Range: FALSE / TRUE

The current state of the motor thermistor trip input, modified by INVERT THERMIST input.

Functional Description

The I/O TRIPS function block allows trips to be generated by signals on the input terminals of the drive. Refer to the Installation Product Manual, Chapter 7 for a description of the trips supported by the drive.

1-36 Programming Your Application

LOCAL CONTROL

This block allows the available modes of Local and Remote operation to be customised. It also indicates the selected mode.

You can only switch between Local and Remote modes using the keypad. Refer to the Installation Product Manual, Chapter 5: "The Keypad" - Selecting Local or Remote Control.

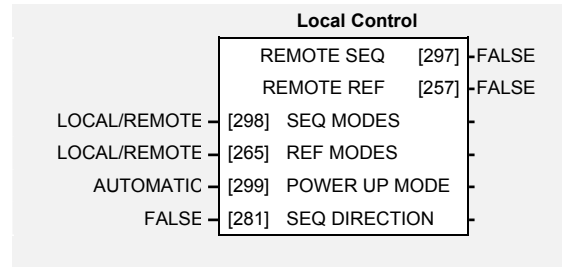

Parameter Descriptions

SEQ MODES

Range: Enumerated - see below

Allows the source of sequencing (stop/start) commands to be selected. Local/Remote allows selection by the L/R key on the keypad. The remaining two selections disable the L/R key for selecting the sequencing commands source and lock the source to be either Local (keypad) or Remote (an external signal to the drive terminals). The modes supported are:

Enumerated Value : SEQ MODE

- 0 : LOCAL/REMOTE
- 1 : LOCAL ONLY
- 2 : REMOTE ONLY

REF MODES

Range: Enumerated - see below

Allows the source of the reference (speed control) signal to be selected. Local/Remote allows selection by the L/R key on the keypad. The remaining two selections disable the L/R key for selecting the reference signal source and lock the source to be either Local (keypad) or Remote (an external signal to the drive terminals). The modes supported are:

Enumerated Value : REF MODE

- 0 : LOCAL/REMOTE
- 1 : LOCAL ONLY
- 2 : REMOTE ONLY

POWER UP MODE

Range: Enumerated - see below

Allows the power-up operating mode of the drive to be selected. Local is the keypad, Remote is an external signal to the drive terminals. Automatic is the same mode as at power-down. The modes supported are:

Enumerated Value : POWER UP MODE

- 0 : LOCAL
- 1 : REMOTE
- 2 : AUTOMATIC

SEQ DIRECTION

Range: FALSE / TRUE

This parameter is used in conjunction with the 6901 Keypad which has a "direction" key, Forward/Reverse.

When this parameter is set to TRUE, the source of the "direction" command is as defined by the SEQ MODES parameter

When this parameter is set to FALSE, the source of the "direction" command is as defined by the REF MODES parameter

REMOTE SEQ

Range: FALSE / TRUE

This parameter indicates the present source of the sequencing commands. When set to FALSE, stop-start commands are from Local (keypad), when TRUE stop-start commands are from Remote (from the terminals).

REMOTE REF

Range: FALSE / TRUE

This parameter indicates the present source of the reference signal. When set to FALSE, speed control is from Local (keypad), when TRUE speed control is from Remote (from the terminals).

LOGIC FUNCTION

These generic function blocks can be configured to perform one of a number of simple functions upon a fixed number of inputs.

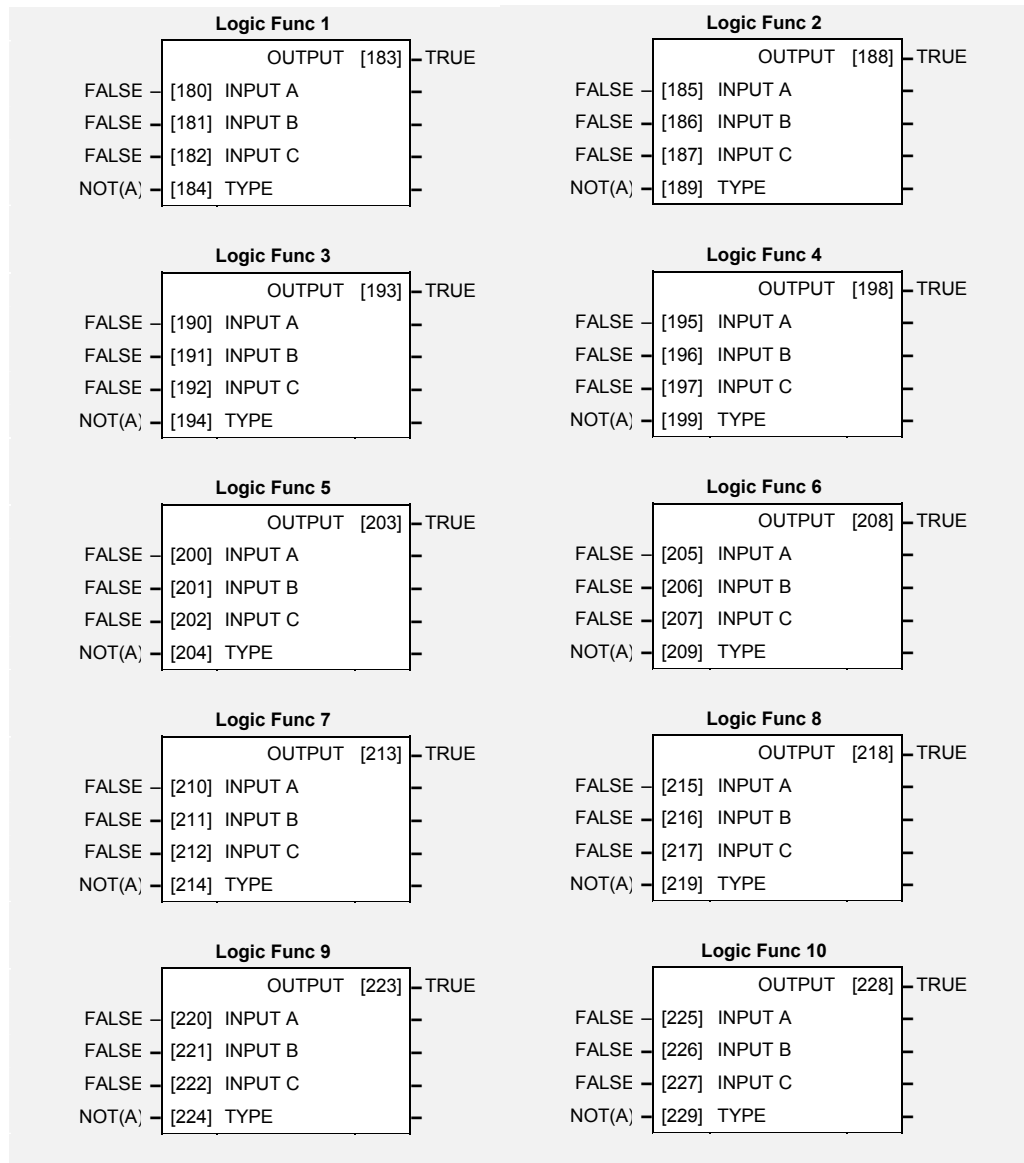

Parameter Descriptions

INPUT A

General purpose logic input.

Range: FALSE / TRUE

INPUT B

General purpose logic input.

Range: FALSE / TRUE

INPUT C

General purpose logic input.

Range: FALSE / TRUE

1-38 Programming Your Application

TYPE

Range: Enumerated - see below

The operation to be performed on the three inputs to produce the output value. The operations that can be selected are:

Enumerated Value : TYPE

- 0 : NOT(A)
- 1 : AND(A,B,C)
- 2 : NAND(A,B,C)
- 3 : OR(A,B,C)
- 4 : NOR(A,B,C)
- 5 : XOR(A,B)
- 6 : 0-1 EDGE(A)
- 7 : 1-0 EDGE(A)
- 8 : AND(A,B,!C)
- 9 : OR(A,B,!C)
- 10 : S FLIP-FLOP
- 11 : R FLIP-FLOP
- 12 : LATCH
- 13 : SWITCH

OUTPUT

Range: FALSE / TRUE

The result of performing the selected operation on the inputs.

Functional Description

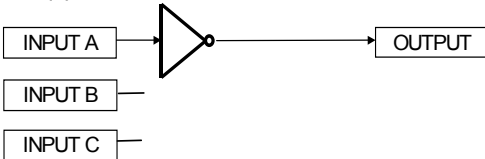
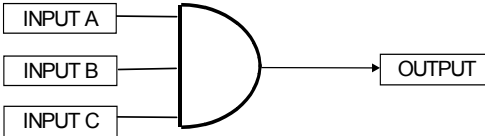
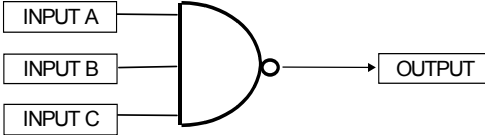
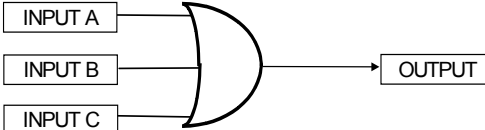
Operation	Description
NOT(A)	<p>NOT(A)</p>  <p>If INPUT A is TRUE the OUTPUT is FALSE, otherwise the OUTPUT is TRUE.</p>
AND(A,B,C)	<p>AND(A,B,C)</p>  <p>If A and B and C are all TRUE then the OUTPUT is TRUE, otherwise the OUTPUT is FALSE.</p>
NAND(A,B,C)	<p>NAND(A,B,C)</p>  <p>If A and B and C are all TRUE then the OUTPUT is FALSE, otherwise the OUTPUT is TRUE.</p>
OR(A,B,C)	<p>OR(A,B,C)</p>  <p>If at least one of A or B or C is TRUE then the OUTPUT is TRUE, otherwise the OUTPUT is FALSE.</p>

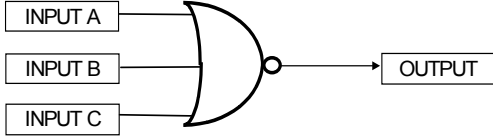
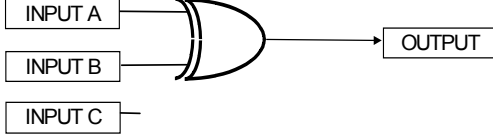
Operation	Description
NOR(A,B,C)	<p>NOR(A,B,C)</p> <p>If at least one of A or B or C is TRUE then the OUTPUT is FALSE, otherwise the OUTPUT is TRUE.</p> 
XOR(A,B)	<p>XOR(A,B)</p> <p>If A and B are the same, (both TRUE or both FALSE), then the output is FALSE, otherwise the output is TRUE.</p> 

0-1 EDGE(A)

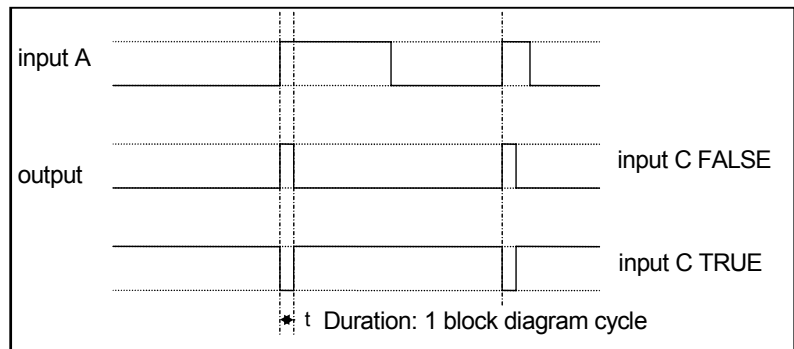

Rising Edge Trigger

Input B is not used.

This function outputs a pulse of 5ms duration when INPUT A to the block becomes TRUE. When INPUT C is TRUE, the output is inverted.

The output is held TRUE for one execution of the function block diagram.

1-0 EDGE(A)

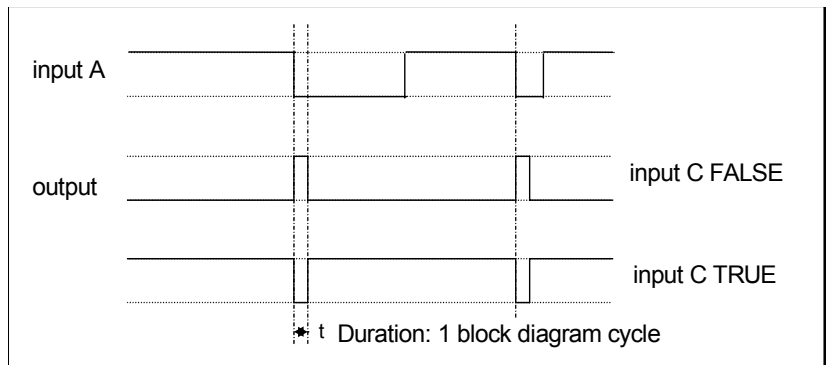

Falling Edge Trigger

Input B is not used.

This function outputs a pulse of 20ms duration when INPUT A to the block becomes FALSE. When INPUT C is TRUE, the output is inverted.

The output is held TRUE for one execution of the function block diagram.

1-40 Programming Your Application

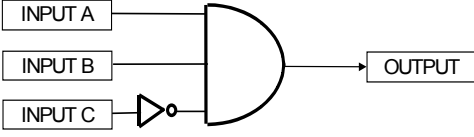
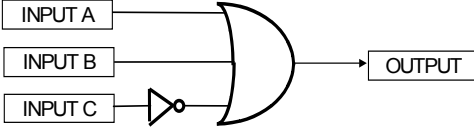
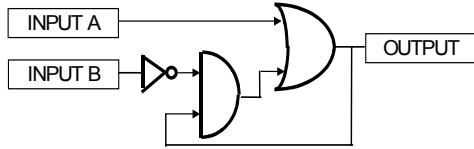
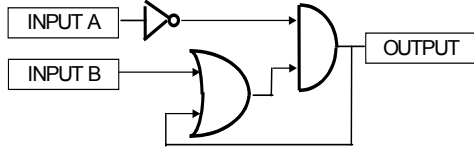
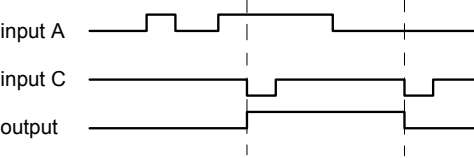
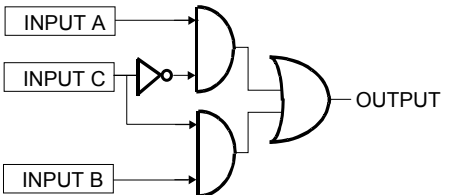
Operation	Description																																					
AND(A,B,!C)	<p>AND(A,B,!C)</p>  <p>Refer to the Truth Table. FALSE = 0, TRUE = 1.</p>	<p>Input State</p> <table border="1"> <thead> <tr> <th>A</th> <th>B</th> <th>C</th> <th>Output State</th> </tr> </thead> <tbody> <tr><td>0</td><td>0</td><td>0</td><td>0</td></tr> <tr><td>0</td><td>0</td><td>1</td><td>0</td></tr> <tr><td>0</td><td>1</td><td>0</td><td>0</td></tr> <tr><td>0</td><td>1</td><td>1</td><td>0</td></tr> <tr><td>1</td><td>0</td><td>0</td><td>0</td></tr> <tr><td>1</td><td>0</td><td>1</td><td>0</td></tr> <tr><td>1</td><td>1</td><td>0</td><td>1</td></tr> <tr><td>1</td><td>1</td><td>1</td><td>0</td></tr> </tbody> </table>	A	B	C	Output State	0	0	0	0	0	0	1	0	0	1	0	0	0	1	1	0	1	0	0	0	1	0	1	0	1	1	0	1	1	1	1	0
A	B	C	Output State																																			
0	0	0	0																																			
0	0	1	0																																			
0	1	0	0																																			
0	1	1	0																																			
1	0	0	0																																			
1	0	1	0																																			
1	1	0	1																																			
1	1	1	0																																			
OR(A,B,!C)	<p>OR(A,B,!C)</p>  <p>Refer to the Truth Table. FALSE = 0, TRUE = 1.</p>	<p>Input State</p> <table border="1"> <thead> <tr> <th>A</th> <th>B</th> <th>C</th> <th>Output State</th> </tr> </thead> <tbody> <tr><td>0</td><td>0</td><td>0</td><td>1</td></tr> <tr><td>0</td><td>0</td><td>1</td><td>0</td></tr> <tr><td>0</td><td>1</td><td>0</td><td>1</td></tr> <tr><td>0</td><td>1</td><td>1</td><td>1</td></tr> <tr><td>1</td><td>0</td><td>0</td><td>1</td></tr> <tr><td>1</td><td>0</td><td>1</td><td>1</td></tr> <tr><td>1</td><td>1</td><td>0</td><td>1</td></tr> <tr><td>1</td><td>1</td><td>1</td><td>1</td></tr> </tbody> </table>	A	B	C	Output State	0	0	0	1	0	0	1	0	0	1	0	1	0	1	1	1	1	0	0	1	1	0	1	1	1	1	0	1	1	1	1	1
A	B	C	Output State																																			
0	0	0	1																																			
0	0	1	0																																			
0	1	0	1																																			
0	1	1	1																																			
1	0	0	1																																			
1	0	1	1																																			
1	1	0	1																																			
1	1	1	1																																			
S FLIP-FLOP	<p>S FLIP-FLOP</p> 	<p>This is a set dominant flip-flop. INPUT A functions as <i>set</i>, and INPUT B as <i>reset</i>.</p>																																				
R FLIP-FLOP	<p>R FLIP-FLOP</p> 	<p>This is a reset dominant flip-flop. INPUT A functions as <i>reset</i>, and INPUT B as <i>set</i>.</p>																																				
LATCH		<p>When INPUT C is low, the output is the value of INPUT A. This output value is then latched until INPUT C is low again. INPUT B is not used.</p>																																				
SWITCH		<p>When INPUT C is FALSE, the output is equal to INPUT A. When INPUT C is TRUE, the output is equal to INPUT B.</p>																																				

MINIMUM SPEED

The minimum speed block is used to determine how the drive will follow a reference. There are two modes

1. Proportional : minimum limit
2. Linear : between minimum and maximum.

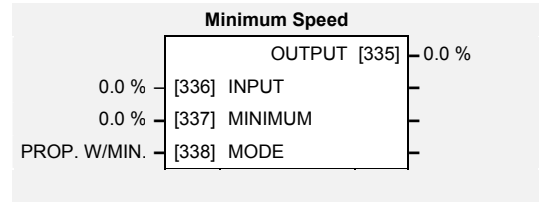

Parameter Descriptions

INPUT

The input for this block.

Range: -300.0 to 300.0 %

MINIMUM

PAR\ P3

This parameter determines the minimum output value from this block

Range: -100.0 to 100.0 %

MODE

SET\SETP ST06

This parameter represents the operating mode of the block. There are two modes:

Range: Enumerated - see below

Enumerated Value : OPERATING MODE

0 : PROP. W/MIN.

1 : LINEAR

OUTPUT

The output is determined by the MODE selected, see below.

Range: —.x %

Functional Description

There are two operating modes for the MINIMUM SPEED block:

Proportional with Minimum

In this mode the MINIMUM SPEED block behaves like a simple clamp. The minimum value has the valid range -100% to 100% and the output is always greater than or equal to the minimum value.

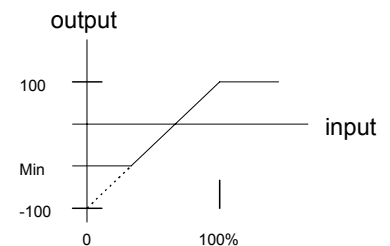

Linear

In this mode the MINIMUM SPEED block first clamps the input to zero then rescales the input such that the output goes linearly between minimum and 100% for an input that goes from 0 to 100%.

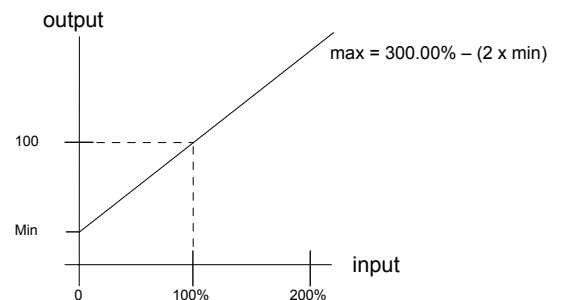

Note the constraints:-

- min \geq 0
- input \geq 0
- max = 100%

1-42 Programming Your Application

MMI ACCESS

This function block contains options associated with operator station password protection and the amount of detail the menu structure will show.

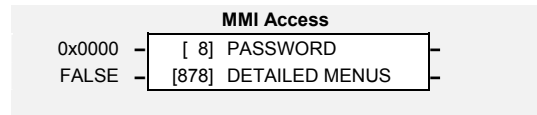

Parameter Descriptions

PASSWORD *PAR\ P99* *Range: 0000 to FFFF*

Setting a non-zero value enables the password feature.

DETAILED MENUS *SET\SETP ST99* *Range: FALSE / TRUE*

Selects Full menu detail for the keypad. The additional parameters shown in the menus are indicated in this manual by **F**.

MOTOR DATA

Designed for all Motor Control Modes.

In this function block you enter the details of the motor under control and any available motor nameplate information.

The Autotune feature will determine the MAG CURRENT, STATOR RES, LEAKAGE INDUC, MUTUAL INDUC and ROTOR TIME CONST motor model parameter.

The OVERLOAD parameter determines the allowed level of motor overload. This can be especially useful when operating with motors smaller than the inverter rating.

Motor Data		
* 50.0 Hz	[1159]	BASE FREQUENCY
* ** 400.0 V	[1160]	MOTOR VOLTAGE
** 20.00 A	[64]	MOTOR CURRENT
** 6.00 A	[65]	MAG CURRENT
* ** 1460.0 rpm	[83]	NAMEPLATE RPM
4 POLE	[84]	MOTOR POLES
VOLTS / HZ	[1157]	CONTROL MODE
** 11.00 kW	[1158]	POWER
* ** STAR	[124]	MOTOR CONNECTION
** 0.86	[242]	POWER FACTOR
** 2.0	[1164]	OVERLOAD
** 0.7698 Ohm	[119]	STATOR RES
** 24.50 mH	[120]	LEAKAGE INDUC
** 98.01 mH	[121]	MUTUAL INDUC
** 379.56 ms	[1163]	ROTOR TIME CONST

Note: Do not attempt to control motors whose rated current is less than 50% of the drive rated current. Poor motor control or Autotune problems may occur if you do.



Parameter Descriptions

BASE FREQUENCY  PAR\ P7 Range: 7.5 to 240.0Hz

This parameter contains the motor nameplate base frequency. Refer to FLUXING, page 1-28.

MOTOR VOLTAGE  SET\CTRL CL12 Range: 0.0 to 575.0V

This parameter contains the motor nameplate voltage at base frequency. Refer to VOLTAGE CONTROL, page 1-80.

MOTOR CURRENT  PAR\ P6 &  SV SET\CTRL CL10 Range: 0.01 to 999.99A

This parameter contains the motor nameplate full-load line current.

MAG CURRENT  SET\CTRL CL14 Range: 0.01 to 999.99A

This parameter contains the motor model no-load line current as determined by the Autotune, or from the motor nameplate.

NAMEPLATE RPM  SET\CTRL CL02 Range: 0.1 to 30000.0 rpm

This parameter contains the motor nameplate full-load rated speed. This is the motor speed in rpm at base frequency minus full load slip.

MOTOR POLES  SV SET\CTRL CL11 Range: Enumerated - see below

This parameter contains the motor nameplate pole-pairs.

Enumerated Value : MOTOR POLES

- 2 : 2 pole
- 4 : 4 pole
- 6 : 6 pole
- 8 : 8 pole
- 10 : 10 pole
- 12 : 12 pole

CONTROL MODE SET\CTRL CL01 Range: Enumerated - see below

Determines the main method of motor control used by the drive.

Enumerated Value : CONTROL MODE

- 0 : VOLTS / HZ
- 1 : SENSORLESS VEC

1-44 Programming Your Application

POWER **M SV** SET\CTRL CL15 *Range: 0.00 to 355.00kW*

This parameter contains the motor nameplate power.

MOTOR CONNECTION **M SV** SET\CTRL CL16 *Range: Enumerated - see below*

This parameter contains the motor nameplate connection.

Enumerated Value : MOTOR CONNECTION

0 : DELTA

1 : STAR

POWER FACTOR *Range: 0.50 to 0.99*

This parameter contains the motor nameplate full-load power factor.

OVERLOAD *Range: 1.0 to 5.0*

This parameter contains the allowable motor overload factor. It is used to match the drive current measurement range to the motor. The drive is set up so that the **Motor Current x Overload** can be measured up to a maximum of 2 x the drive constant torque current rating.

The OVERLOAD parameter has no effect on the current, inverse time or torque limits.

STATOR RES **F M SV** SET\CTRL CL17 *Range: 0.0000 to 250.0000 Ohm*

This parameter contains the motor model per-phase stator resistance as determined by Autotune.

LEAKAGE INDUC **F M SV** SET\CTRL CL18 *Range: 0.00 to 300.00 mH*

This parameter contains the motor model per-phase leakage inductance as determined by Autotune.

MUTUAL INDUC **F M SV** SET\CTRL CL19 *Range: 0.00 to 3000.00 mH*

This parameter contains the motor model per-phase mutual inductance as determined by Autotune.

ROTOR TIME CONST **F M SV** SET\CTRL CL1A *Range: 10.00 to 3000.00*

This parameter contains the motor model rotor time constant as determined by Autotune.

MULTIPLEXER

The block collects together 16 Boolean input values into a single word.

For example, it may be used to set and clear individual bits within a word such as the TRIGGERS 1 word for the AUTO RESTART function block.

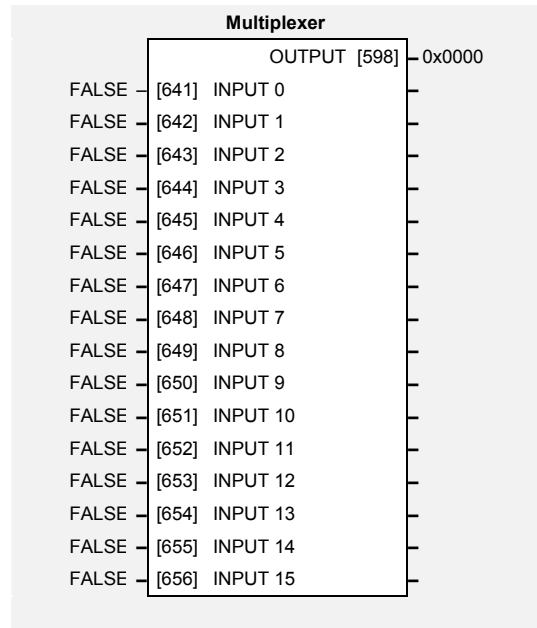

Parameter Descriptions

INPUT 0 TO INPUT 15

The Boolean inputs to be assembled into a single word.

Range: FALSE / TRUE

OUTPUT

The resulting word.

Range: 0000 to FFFF

1-46 Programming Your Application

PATTERN GEN

Designed for all Motor Control Modes.

The pattern generator function block allows you to configure the drive PWM (Pulse Width Modulator) operation.

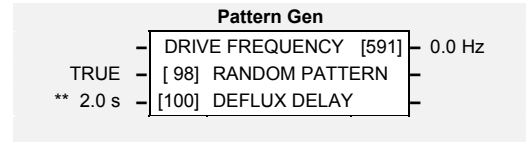

Parameter Descriptions

RANDOM PATTERN

Range: FALSE / TRUE

This parameter selects between random pattern (quiet motor noise) or the more conventional fixed carrier PWM strategies. When TRUE, random pattern is enabled.

DEFLUX DELAY

Range: 0.1 to 10.0 s

Sets the minimum allowed delay between disabling and then re-enabling PWM production (i.e. stopping and starting the drive).

DRIVE FREQUENCY *DIAG 1*

Range: —.x Hz

This indicates the drive output frequency.

Functional Description

The drive provides a unique quiet pattern PWM strategy in order to reduce audible motor noise. The user is able to select between the quiet pattern or the more conventional fixed carrier frequency method. With the quiet pattern strategy selected (random pattern enabled), audible motor noise is reduced to a dull hiss.

PID

This function block allows the drive to be used in applications requiring a trim to the setpoint, depending on feedback from an external measurement device. Typically this will be used for process control, i.e. pressure or flow.

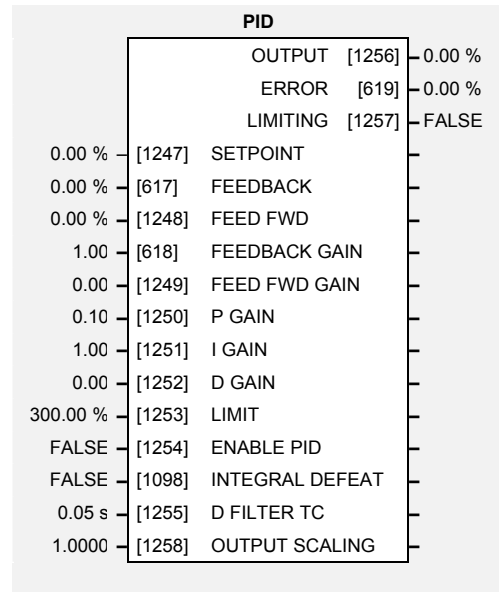

Parameter Descriptions

SETPOINT

The input setpoint to the PID block.

Range: -300.00 to 300.00 %

FEEDBACK

The feedback input to the PID block.

Range: -300.00 to 300.00 %

FEED FWD

The feed forward input to the PID block.

Range: -300.00 to 300.00 %

FEEDBACK GAIN PAR\ P505

The feedback gain of the PID block.

Range: -10.00 to 10.00

FEED FWD GAIN

The feed forward gain of the PID block.

Range: -10.00 to 10.00

P GAIN *PAR\ P501*

The Proportional gain of the PID block.

Range: 0.00 to 100.00

I GAIN *PAR\ P502*

The Integral gain of the PID block.

Range: 0.00 to 100.00

D GAIN PAR\ P503

The Derivative gain of the PID block.

Range: 0.00 to 100.00

LIMIT PAR\ P506

This parameter determines the maximum positive and negative limits of the PID output.

Range: 0.00 to 300.00 %

ENABLE PID

When TRUE, the PID output operates normally; when FALSE, the output is zero and the integral term is reset to zero.

Range: FALSE / TRUE

INTEGRAL DEFEAT

This parameter resets the integral term to zero when TRUE.

Range: FALSE / TRUE

D FILTER TC PAR\ P504

In order to help attenuate high frequency noise on the PID output, a first order output filter has been provided. This parameter determines the output filter time constant.

Range: 0.05 to 5.00 s

1-48 Programming Your Application

OUTPUT

The output of the PID function.

Range: *xx.xx %*

ERROR

The result of SETPOINT - FEEDBACK x FEEDBACK GAIN.

Range: *xx.xx %*

LIMITING

This output is TRUE if the output is at the LIMIT value.

Range: *FALSE / TRUE*

OUTPUT SCALING

This parameter represents an overall scaling factor which is applied after the PID positive and negative clamps.

Range: *-3.0000 to 3.0000*

Functional Description

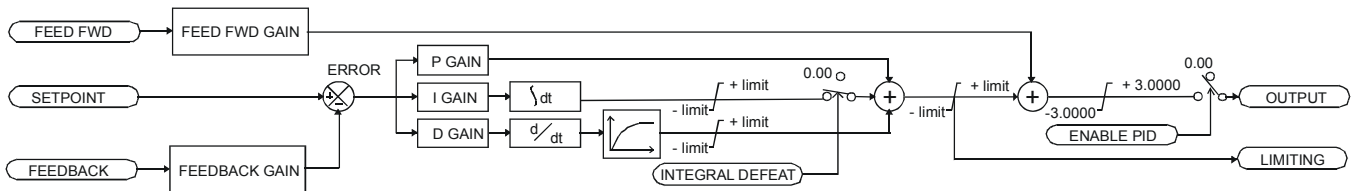

For an application that requires closed loop control, the error term may be derived from the setpoint and feedback using a value function block. This error term is then used by the PID. The output of the PID may be used to trim the demand setpoint via the SPEED TRIM parameter in the REFERENCE function block.

PRESET

Each block is used to select a value from one of eight inputs, depending on the value of another input. A second output is provided to allow the block to be used as two banks of four inputs.

The Range of preset inputs is -32768.0 to 32767.

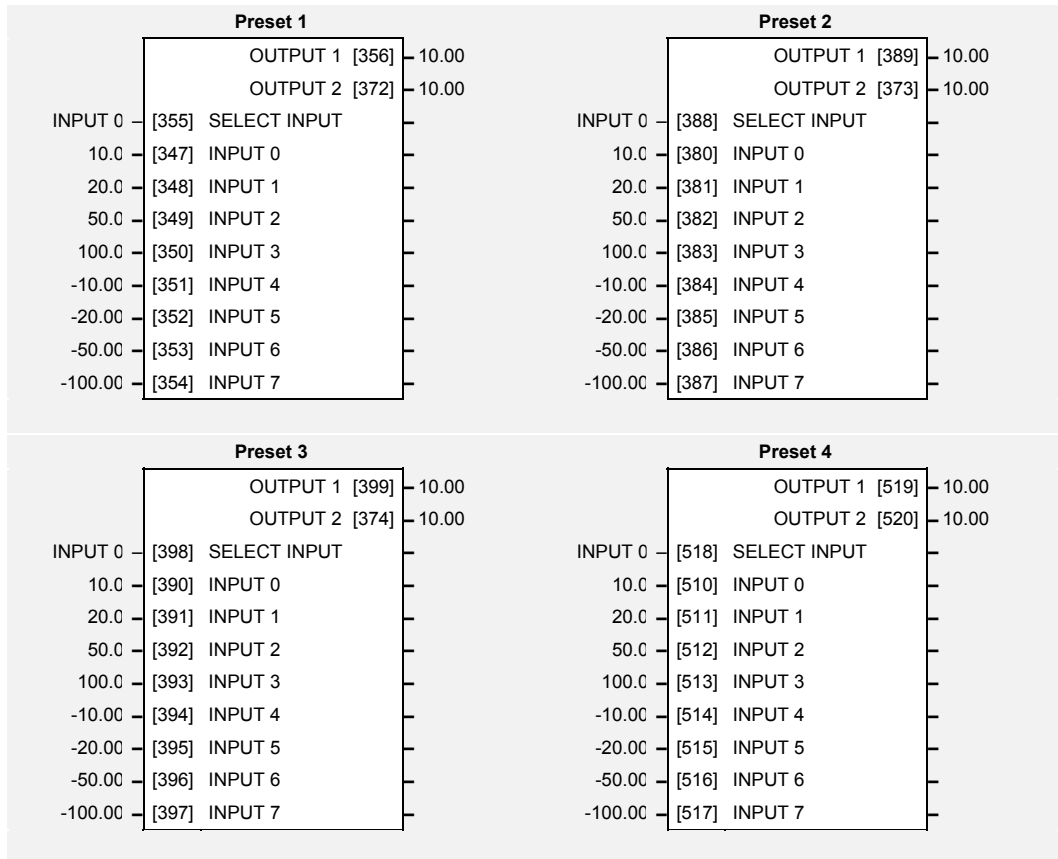

Parameter Descriptions

SELECT INPUT

Range: Enumerated - see below

Determines which of the inputs is routed to OUTPUT 1. In addition, if SELECT INPUT is in the range 0 to 3, INPUT 4 to INPUT 7 respectively is routed to OUTPUT 2.

Enumerated Value : SELECT INPUT

- 0 : INPUT 0
- 1 : INPUT 1
- 2 : INPUT 2
- 3 : INPUT 3
- 4 : INPUT 4
- 5 : INPUT 5
- 6 : INPUT 6
- 7 : INPUT 7

INPUT 0 TO INPUT 7

PAR\ P301 to P308

Range: -300.00 to 300.00

Inputs to the Preset block.

OUTPUT 1

Selected input.

Range: —.xx

OUTPUT 2

Selected input (if SELECT INPUT is in the correct range).

Range: —.xx

1-50 Programming Your Application

Functional Description

The Preset function block is a de-multiplexer.

OUTPUT 1 and OUTPUT 2 return the values at selected inputs set by SELECT INPUT.

OUTPUT 2 returns the value of a different input to OUTPUT 1, i.e:

if SELECT INPUT = 0 then OUTPUT 1 = INPUT 0, OUTPUT 2 = INPUT 4

if SELECT INPUT = 1 then OUTPUT 1 = INPUT 1, OUTPUT 2 = INPUT 5 etc.

When SELECT INPUT is set to 4, 5, 6 or 7, OUTPUT 2 will return a value of zero.

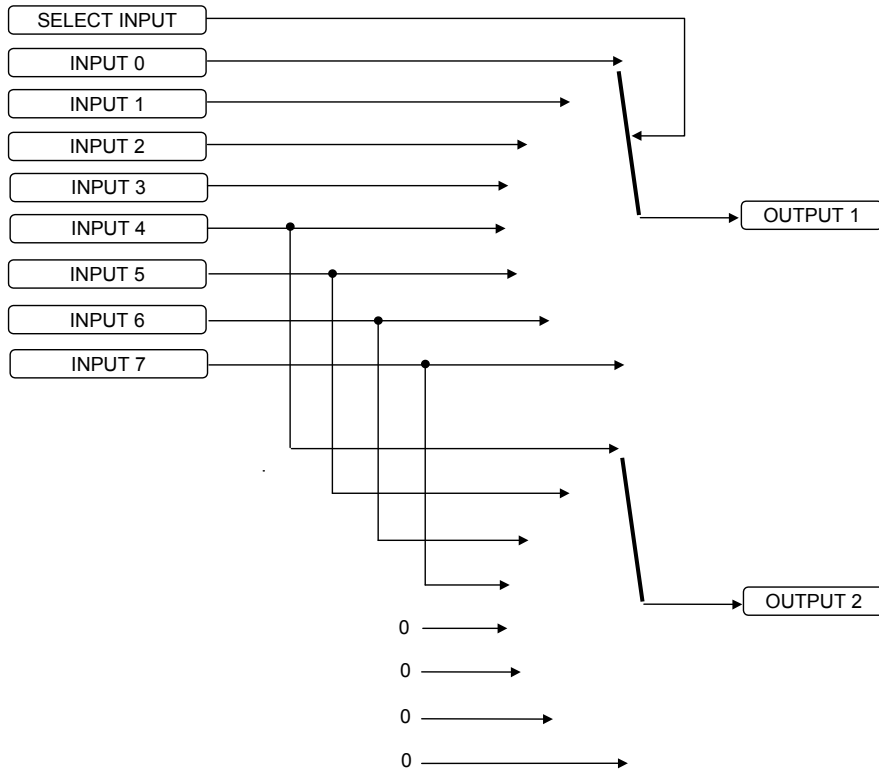

RAISE/LOWER

This function block acts as an internal motorised potentiometer (MOP).

The OUTPUT is preserved during power-down of the drive.

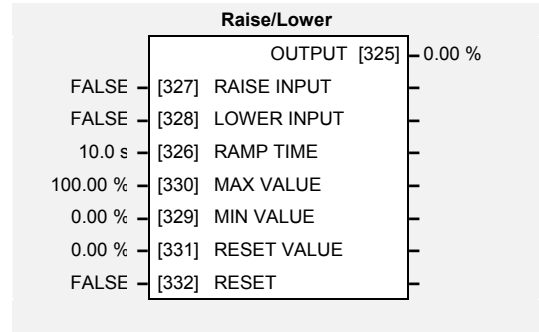

Parameter Descriptions

RAISE INPUT

When TRUE causes OUTPUT to ramp up.

Range: FALSE / TRUE

LOWER INPUT

When TRUE causes OUTPUT to ramp down.

Range: FALSE / TRUE

RAMP TIME

PAR\ P401

Range: 0.0 to 600.0 s

Rate of change of the OUTPUT . Defined as time to change from 0.00% to 100.00% . Note that the raise and lower rates are always the same.

MAX VALUE

PAR\ P402

Range: -100.00 to 100.00 %

The maximum value to which OUTPUT will ramp up to.

MIN VALUE

PAR\ P403

Range: -100.00 to 100.00 %

The minimum value to which OUTPUT will ramp down to.

RESET VALUE

PAR\ P404

Range: -100.00 to 100.00 %

The value the OUTPUT is set to when RESET is TRUE.

RESET

When TRUE, forces OUTPUT to track RESET VALUE .

Range: FALSE / TRUE

OUTPUT

The ramped output. This parameter is persistent, that is, it is saved throughout a power failure.

Range: —.xx %

Functional Description

The table below describes how OUTPUT is controlled by the RAISE INPUT, LOWER INPUT and RESET inputs.

RESET	RAISE INPUT	LOWER INPUT	Action
TRUE	Any	Any	OUTPUT tracks RESET VALUE
FALSE	TRUE	FALSE	OUTPUT ramps up to MAX VALUE at RAMP TIME
FALSE	FALSE	TRUE	OUTPUT ramps down to MIN VALUE at RAMP TIME
FALSE	FALSE	FALSE	OUTPUT not changed. *
FALSE	TRUE	TRUE	OUTPUT not changed. *

* If OUTPUT is greater than MAX VALUE the OUTPUT will ramp down to MAX VALUE at RAMP TIME. If OUTPUT is less than MIN VALUE the OUTPUT will ramp up to MIN VALUE at RAMP TIME.

IMPORTANT: If MAX VALUE is less than MIN VALUE then OUTPUT will be either the MIN VALUE or the MAX VALUE depending on its initial value.

1-52 Programming Your Application

REFERENCE

This function block holds all the parameters concerning the generation of the setpoint reference.

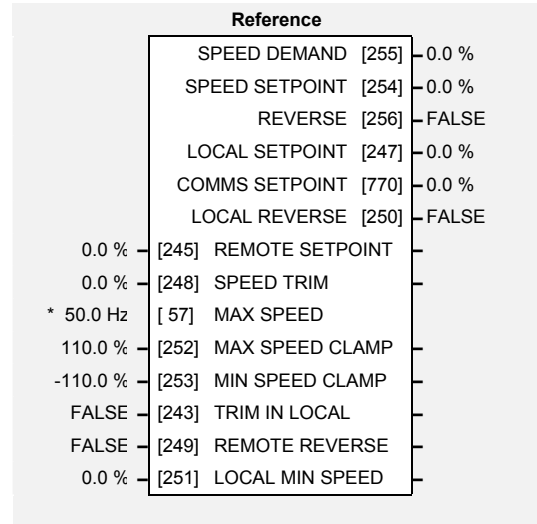

Parameter Descriptions

REMOTE SETPOINT

Range: -110.0 to 110.0 %

This is the target reference that the drive will ramp to in remote reference mode (not including trim), direction is taken from REMOTE REVERSE and the sign of REMOTE SETPOINT.

SPEED TRIM

Range: -110.00 to 110.00 %

The trim is added to the ramp output in remote mode (or if TRIM IN LOCAL is TRUE) to form SPEED DEMAND. The trim is typically connected to the output of a PID in a closed loop system. Note that the output of the REFERENCE RAMP block is set to - SPEED TRIM when the drive is started. This ensures that the SPEED DEMAND ramps from zero.

MAX SPEED

M PAR\ P2

Range: 7.5 to 300.0 Hz

The maximum speed of the drive in electrical Hertz (Hz).

MAX SPEED CLAMP

Range: 0.0 to 110.0 %

Maximum value for SPEED DEMAND.

MIN SPEED CLAMP

Range: -110.0 to 0.0 %

Minimum value for SPEED DEMAND.

TRIM IN LOCAL

Range: FALSE / TRUE

When TRUE, SPEED TRIM is always added to the ramp output. When FALSE, SPEED TRIM is added only in Remote mode.

REMOTE REVERSE

Range: FALSE / TRUE

Demanded direction when in Remote Reference mode. This is usually connected directly to the Sequencing Logic.

LOCAL MIN SPEED

F SET\SETP ST51

Range: 0.0 to 100.0 %

The magnitude of the minimum setpoint that will be used when running in Local Mode.

SPEED DEMAND

Range: —.x %

Indicates actual speed demand. This is the input to the frequency controller.

SPEED SETPOINT

DIAG 2

Range: —.x %

This diagnostic indicates target speed. This will be equal to either LOCAL SETPOINT, REMOTE SETPOINT, JOG SETPOINT or COMMS SETPOINT. (Refer to the REFERENCE JOG function block for the JOG SETPOINT parameter).

REVERSE

Range: FALSE / TRUE

Indicates demanded direction. This may not be the actual direction as no account of setpoint sign is taken.

LOCAL SETPOINT

Range: $-x\%$

Indicates the Operator Station setpoint. It is saved on power down. Direction is taken from LOCAL REVERSE.

COMMS SETPOINT

Range: $-x\%$

This setpoint is the target reference that the drive will ramp to in Remote Reference Comms mode (not including trim). The direction is always positive, i.e. forward.

LOCAL REVERSE

Range: FALSE / TRUE

Indicates demanded direction in Local Reference mode, saved on power-down.

Functional Description

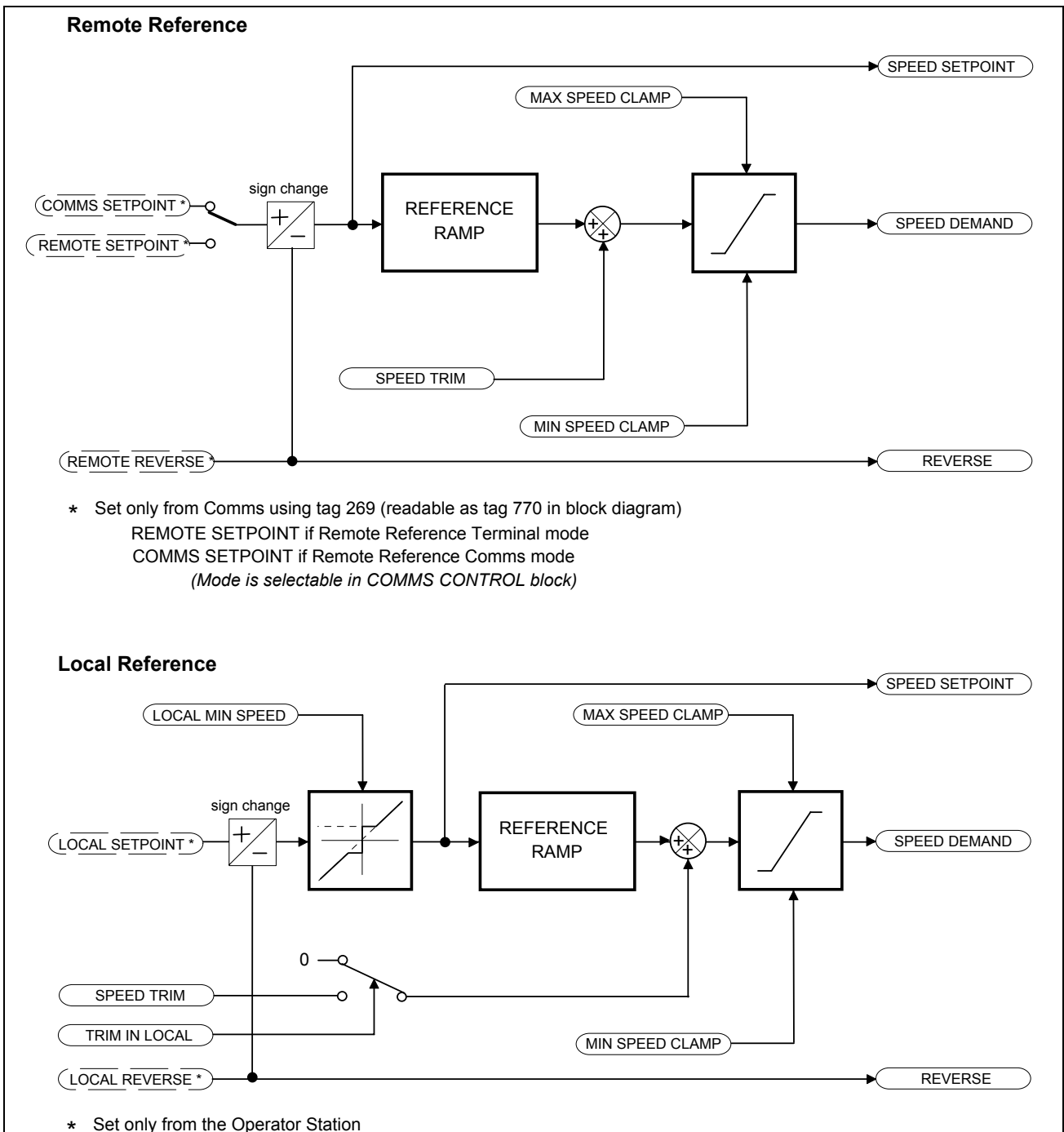

1-54 Programming Your Application

REFERENCE JOG

This block holds all the parameters that concern the Jog functionality on the drive.

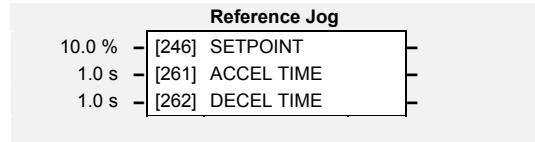

Parameter Descriptions

SETPOINT *PAR\ P8* *Range: -100.0 to 100.0 %*
The setpoint is the target reference that the drive will ramp to.

ACCEL TIME *SET\SETP ST01* *Range: 0.0 to 3000.0 s*
The time that the drive will take to ramp the jog setpoint from 0.00% to 100.00%.

DECEL TIME *SET\SETP ST02* *Range: 0.0 to 3000.0 s*
The time that the drive will take to ramp the jog setpoint from 100.00% to 0.00%.

Functional Description

The REFERENCE JOG function block is used to configure the action of the drive when used in jog mode.

Start/Stop Controlled Remotely

When the JOG input is TRUE, the SPEED DEMAND (REFERENCE function block) ramps up to the jog SETPOINT at a ramp rate set by jog ACCEL TIME. The drive will continue to run at the jog SETPOINT while the JOG input remains TRUE.

Start/Stop Controlled Locally (6901 keypad)

When the JOG key is pressed and held, the SPEED DEMAND (REFERENCE function block) ramps up to the jog SETPOINT at a ramp rate set by jog ACCEL TIME. Release the jog key to "stop" the drive.

Interaction between RUN and JOG

Only one of these signals can be in effect at any one time; the other signal is ignored. The drive must be "stopped" to change from running to jogging, or vice versa.

REFERENCE RAMP

This function block forms part of the reference generation. It provides the facility to control the rate at which the drive will respond to a changing setpoint demand.

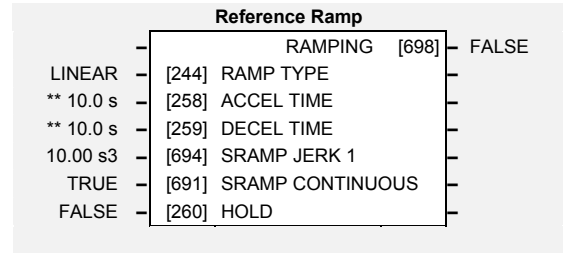

Parameter Descriptions

RAMP TYPE *SET\SETP ST03* *Range: Enumerated - see below*

Select the ramp type:

Enumerated Value : RAMP TYPE

0 : LINEAR
 1 : S

ACCEL TIME *PAR\ P4* *Range: 0.0 to 3000.0 s*

The time that the drive will take to ramp the setpoint from 0.00% to 100.00%.

DECEL TIME *PAR\ P5* *Range: 0.0 to 3000.0 s*

The time that the drive will take to ramp the setpoint from 100.00% to 0.00%.

SRAMP JERK 1 *SET\SETP ST04* *Range: 0.00 to 100.00 s3*

Rate of change of acceleration for the first segment of the curve in units per second³, i.e. if the full speed of the machine is 1.25m/s then the acceleration will be:

$$1.25 \times 50.00\% = 0.625\text{m/s}^3$$

SRAMP CONTINUOUS *SET\SETP ST05* *Range: FALSE / TRUE*

When TRUE, and S ramp is selected in RAMP TYPE, forces a smooth transition if the speed setpoint is changed when ramping. The curve is controlled by the SRAMP ACCEL and SRAMP JERK 1 to SRAMP JERK 4 parameters. When FALSE, there is an immediate transition from the old curve to the new curve.

RAMP HOLD *Range: FALSE / TRUE*

When TRUE the output of the ramp is held at its last value.

RAMPING *Range: FALSE / TRUE*

Set TRUE when ramping.

1-56 Programming Your Application

Functional Description

The ramp output takes the form shown below.

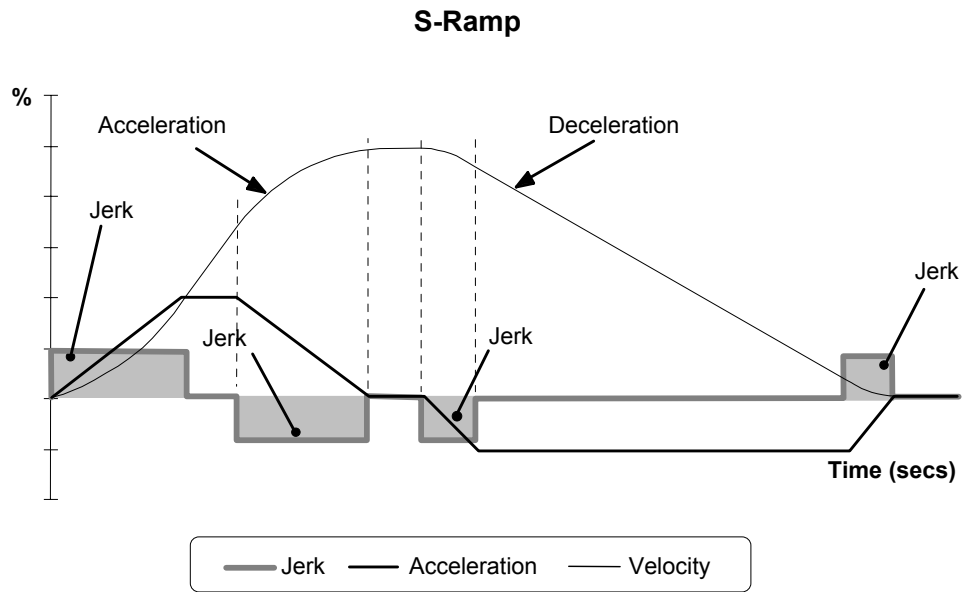

REFERENCE STOP

This function block holds all the parameters concerning the stopping method of the drive.

Reference Stop		
RAMPED	[279]	RUN STOP MODE
10.0 s	[263]	STOP TIME
0.1 %	[266]	STOP ZERO SPEED
0.5 s	[284]	STOP DELAY
RAMPED	[304]	FAST STOP MODE
30.0 s	[275]	FAST STOP LIMIT
0.1 s	[264]	FAST STOP TIME
1200 Hz/s	[126]	FINAL STOP RATE

Parameter Descriptions

RUN STOP MODE *PAR\ P9* *Range: Enumerated - see below*

Selects stopping mode that the controller will use once the run command has been removed. The choices are:

Enumerated Value : STOPPING MODEe

0 : RAMPED

1 : COAST

2 : DC INJECTION

When RAMPED is selected the drive will decelerate using the reference ramp deceleration time, provided it is non zero. When COAST is selected the motor will free-wheel. When DC INJECTION is selected the motor is stopped by applying dc current.

STOP TIME *Range: 0.0 to 600.0 s*

Rate at which the demand is ramped to zero after the ramp has been quenched.

STOP ZERO SPEED *Range: 0.0 to 100.0 %*

Threshold for zero speed detection used by stop sequences.

STOP DELAY *Range: 0.0 to 30.0 s*

Sets the time at which the drive holds zero speed before quenching after a normal stop or a jog stop. This may be particularly useful if a mechanical brake requires time to operate at zero speed, or for jogging a machine to position.

FAST STOP MODE *Range: Enumerated - see below*

Selects stopping mode used during a fast stop, two options ramped or coast.

Enumerated Value : STOPPING MODE

0 : RAMPED

1 : COAST

FAST STOP LIMIT *Range: 0.0 to 3000.0 s*

Maximum time that the drive will try to Fast Stop, before quenching.

FAST STOP TIME *Range: 0.0 to 600.0 s*

Rate at which the SPEED DEMAND is ramped to zero (see REFERENCE function block)

FINAL STOP RATE *Range: 12 to 4800 Hz/s*

Rate at which any internally generated setpoint trims are removed. For example, the trim due to the slip compensation block.

1-58 Programming Your Application

SEQUENCING LOGIC

This function block contains all the parameters relating to the sequencing (start and stop) of the drive.

Before the drive will respond to the RUN FWD, RUN REV or JOG parameters (cause the drive to run or jog), the parameters DRIVE ENABLE, NOT FAST STOP and NOT COAST STOP need to be set to TRUE. In addition, the drive needs to be healthy (HEALTHY is TRUE). The drive will only respond to RUN FWD, RUN REV and JOG if the drive is in the Remote Sequencing mode.

If RUN FWD and RUN REV are TRUE, both are ignored and the drive will stop.

Sequencing Logic		
	TRIPPED	[289] FALSE
	RUNNING	[285] FALSE
	JOGGING	[302] FALSE
	STOPPING	[303] FALSE
	OUTPUT CONTACTOR	[286] FALSE
	SWITCH ON ENABLE	[288] TRUE
	SWITCHED ON	[306] FALSE
	READY	[287] FALSE
	SYSTEM RESET	[305] FALSE
	SEQUENCER STATE	[301] START ENABLED
	REMOTE REV OUT	[296] FALSE
	HEALTHY	[274] TRUE
	FAN RUNNING	[620] FALSE
FALSE	[291] RUN FORWARD	
FALSE	[292] RUN REVERSE	
FALSE	[293] NOT STOP	
FALSE	[280] JOG	
TRUE	[1235] CONTACTOR CLOSED	
TRUE	[276] DRIVE ENABLE	
TRUE	[277] NOT FAST STOP	
TRUE	[278] NOT COAST STOP	
FALSE	[294] REMOTE REVERSE	
FALSE	[282] REM TRIP RESET	
TRUE	[290] TRIP RST BY RUN	
TRUE	[283] POWER UP START	

Parameter Descriptions

RUN FWD

Range: FALSE / TRUE

Setting this parameter to TRUE causes the drive to run in the forward direction.

RUN REV

Range: FALSE / TRUE

Setting this parameter to TRUE causes the drive to run in the reverse direction.

NOT STOP

Range: FALSE / TRUE

Setting this parameter TRUE will latch the RUN FWD or RUN REV commands. Once latched, they can be reset to FALSE and the drive will continue to run. Setting NOT STOP to FALSE causes the run commands to be unlatched.

JOG

Range: FALSE / TRUE

Setting this parameter TRUE causes the drive to run at the speed set by JOG SETPOINT (refer to the REFERENCE JOG function block). Once jogging, setting JOG to FALSE causes the drive to ramp to zero.

CONTACTOR CLOSED

Range: FALSE / TRUE

Feedback used to indicate that the external contactor has been closed. It must be TRUE for the sequencer to proceed from the SWITCHED ON state to the READY STATE, refer to SEQUENCER STATE.

DRIVE ENABLE

Range: FALSE / TRUE

This provides a means of electronically inhibiting drive operation. Whilst running, setting this parameter to FALSE disables the drive operation and causes the motor to coast.

NOT FAST STOP

Range: FALSE / TRUE

Whilst running or jogging, setting this parameter to FALSE causes the drive to ramp to zero. The rate is set by FAST STOP RATE in the STOP function block. The action of setting NOT FAST STOP to TRUE is latched. The drive cannot be restarted until fast stop is completed. This signal is effective even when the drive is in Local mode.

NOT COAST STOP

Range: FALSE / TRUE

Setting this parameter to FALSE disables the drive operation and causes the motor to coast. The action of setting this parameter to TRUE is latched. The drive can not be restarted until the coast stop is completed. This signal is effective even when the drive is in Local mode.

REMOTE REVERSE	<i>Range: FALSE / TRUE</i>
For remote setpoints, setting this to TRUE inverts the demanded direction of motor rotation.	
REM TRIP RESET	<i>Range: FALSE / TRUE</i>
On a transition to TRUE, this input clears latched trips.	
TRIP RST BY RUN	<i>Range: FALSE / TRUE</i>
This allows the rising edge of run command to clear latched trips.	
POWER UP START	<i>Range: FALSE / TRUE</i>
If TRUE, this allows the drive to go directly to run mode if in remote and a run command is present. If FALSE, a low to high transition of the run command is required.	
TRIPPED	<i>Range: FALSE / TRUE</i>
Indicates that there is a latched trip present.	
RUNNING	<i>Range: FALSE / TRUE</i>
Indicates that that the drive is in the enabled state.	
JOGGING	<i>Range: FALSE / TRUE</i>
Indicates that the drive is in the JOG mode.	
STOPPING	<i>Range: FALSE / TRUE</i>
Indicates that the drive is stopping.	
OUTPUT CONTACTOR	<i>Range: FALSE / TRUE</i>
Output to be used to drive an external contactor in the motor output. This contactor is normally closed unless a Trip condition has occurred or the drive goes into the re-configuration mode.	
SWITCH ON ENABLE	<i>Range: FALSE / TRUE</i>
Sometimes referred to as READY TO SWITCH ON, this parameter indicates that the drive will accept a run command.	
SWITCHED ON	<i>Range: FALSE / TRUE</i>
Run accepted. Waiting for CONTACTOR CLOSED and deflux to be completed	
READY	<i>Range: FALSE / TRUE</i>
Indicates that the drive's power stack is operable and the drive will run if enabled.	
SYSTEM RESET	<i>Range: FALSE / TRUE</i>
TRUE for a single block diagram execution cycle after drive enters either RUN or JOG mode.	
SEQUENCER STATE	<i>Range: Enumerated - see below</i>
This parameter indicates the current sequencing state: <i>Enumerated Value : STATE</i>	
	0 : START DISABLED
	1 : START ENABLED
	2 : SWITCHED ON
	3 : READY
	4 : ENABLED
	5 : F-STOP ACTIVE
	6 : TRIP ACTIVE
	7 : TRIPPED
REMOTE REV OUT	<i>Range: FALSE / TRUE</i>
This parameter indicates the current state of remote direction and RUN REV. Note - this is the demanded direction, not the actual direction.	
HEALTHY	<i>Range: FALSE / TRUE</i>
Set FALSE when the drive trips, and set TRUE when the run command is removed. This output is False while the pre-charge relay is open on power-up.	
FAN RUNNING	<i>Range: FALSE / TRUE</i>
This diagnostic is TRUE is the drive's cooling fans are running.	

1-60 Programming Your Application

SKIP FREQUENCIES

This function block may be used to prevent the drive operating at frequencies that cause mechanical resonance in the load.

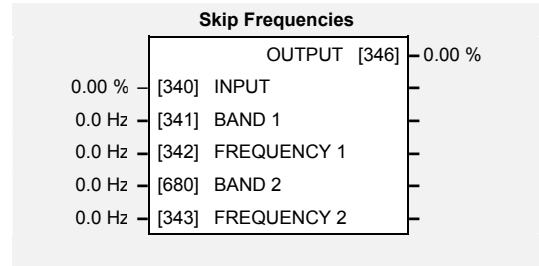

Parameter Descriptions

INPUT

The value of the block input in %.

Range: -300.00 to 300.00 %

BAND 1

The width of each skip band in Hz.

SET\SETP ST12

Range: 0.0 to 60.0 Hz

FREQUENCY 1

This parameter contains the centre frequency of each skip band in Hz.

SET\SETP ST11

Range: 0.0 to 240.0 Hz

BAND 2

The width of each skip band in Hz.

SET\SETP ST14

Range: 0.0 to 60.0 Hz

FREQUENCY 2

This parameter contains the centre frequency of each skip band in Hz.

SET\SETP ST13

Range: 0.0 to 240.0 Hz

OUTPUT

Diagnostic on the output of the function block in %

Range: —.xx %

Functional Description

Two programmable skip frequencies are available to avoid resonances within the mechanical system. Enter the value of frequency that causes the resonance using the “FREQUENCY” parameter and then programme the width of the skip band using its “BAND” parameter. The drive will then avoid sustained operation within the forbidden band as shown in the diagram. The skip frequencies are symmetrical and thus work in forward and reverse.

Note: *Setting the FREQUENCY to 0 disables the corresponding band.
Setting the BAND to 0 causes the value of BAND 1 to be used for this band.*

The behaviour of this function block is illustrated below.

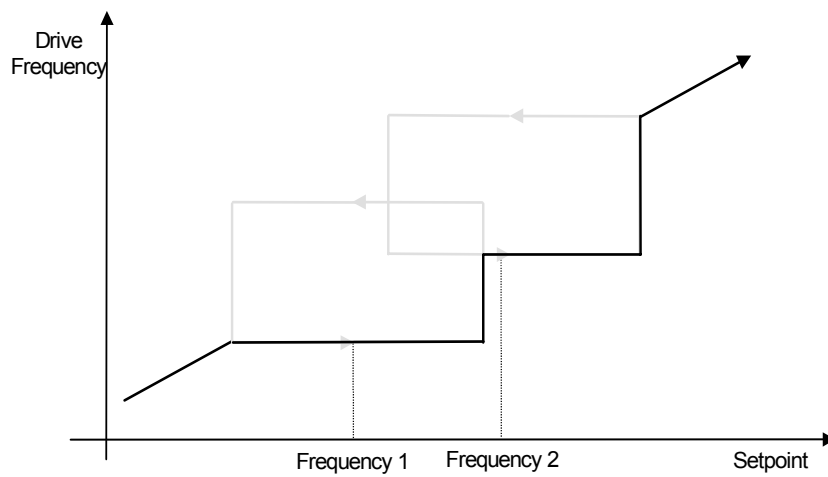
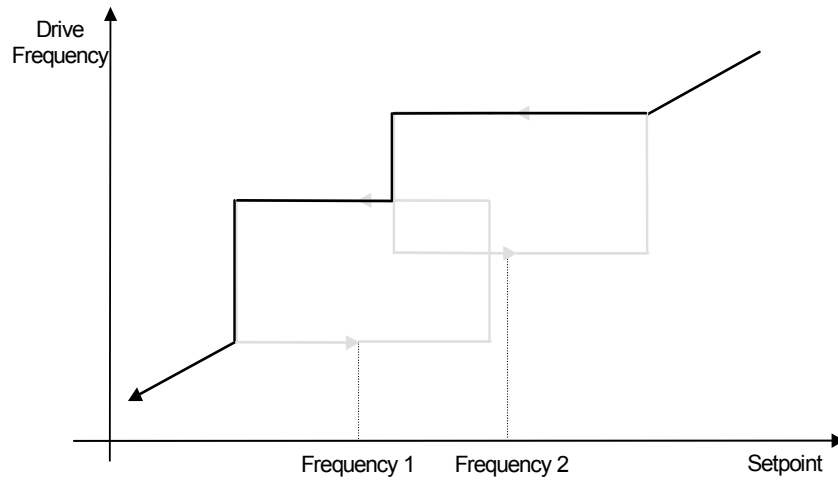
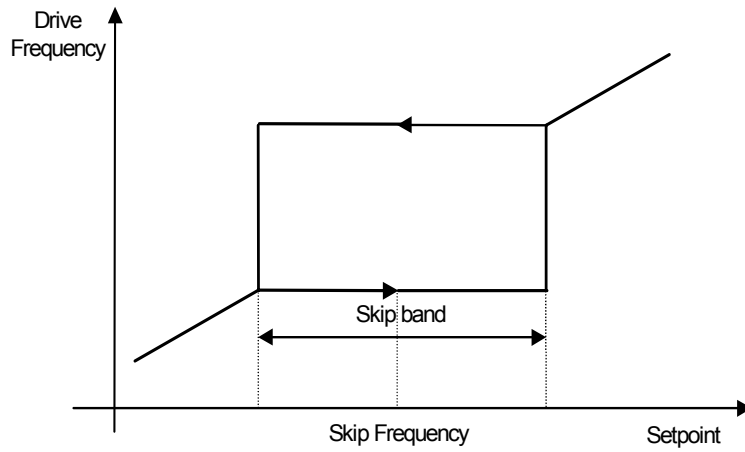

1-62 Programming Your Application

SLEW RATE LIMIT

Designed for all Motor Control Modes.

This function block prevents over-current and over-voltage faults occurring due to a rapidly changing setpoint.

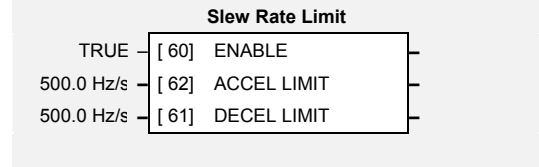

Parameter Descriptions

ENABLE

Range: FALSE / TRUE

When this parameter is FALSE, this function block is disabled and the setpoint is unaffected by this function block.

ACCEL LIMIT

Range: 1.0 to 1200.0 Hz/s

The maximum rate at which the setpoint may accelerate away from zero.

DECEL LIMIT

Range: 1.0 to 1200.0 Hz/s

The maximum rate at which the setpoint may decelerate towards zero.

Functional Description

The SLEW RATE LIMIT block obtains the setpoint from the output of the application, correctly scaled by the SETPOINT SCALE block. The rate of change limits are applied and the setpoint is then passed on for further processing.

When the braking block determines that the internal dc link voltage is too high it issues a Hold signal. This causes the SLEW RATE LIMIT block to hold the setpoint at its current value. This typically lasts for only 1ms, time for the excess energy to be dumped into the braking resistor.

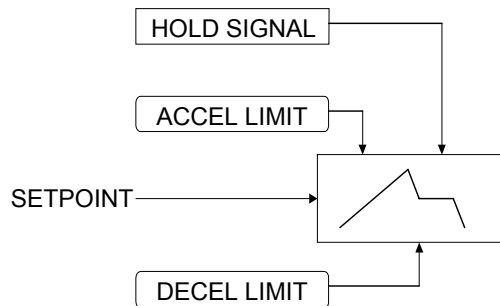

SLIP COMP

Designed for VOLTS/Hz motor Control Mode.

The slip compensation function block allows the drive to maintain motor speed in the presence of load disturbances.

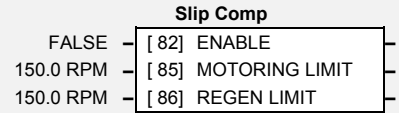

Parameter Descriptions

ENABLE  SET\CTRL CL04 *Range: FALSE / TRUE*

For the slip compensation to be operational this must be TRUE. Eliminates motor speed variations under load conditions in V/F fluxing mode when the correct value for MAG CURRENT is entered into ^SCL14

MOTORING LIMIT *Range: 0.0 to 600.0 rpm*

The maximum trim that will be produced by the slip compensation block when the motor is driving the load (motoring).

REGEN LIMIT *Range: 0.0 to 600.0 rpm*

The maximum trim that will be produced by the slip compensation block when the motor is being driven by the load, (regenerating).

Functional Description

Based on the rated speed, the no load speed and the rated load of the motor, the slip compensation block adjusts the demand frequency to compensate for any speed slippage resulting from the load.

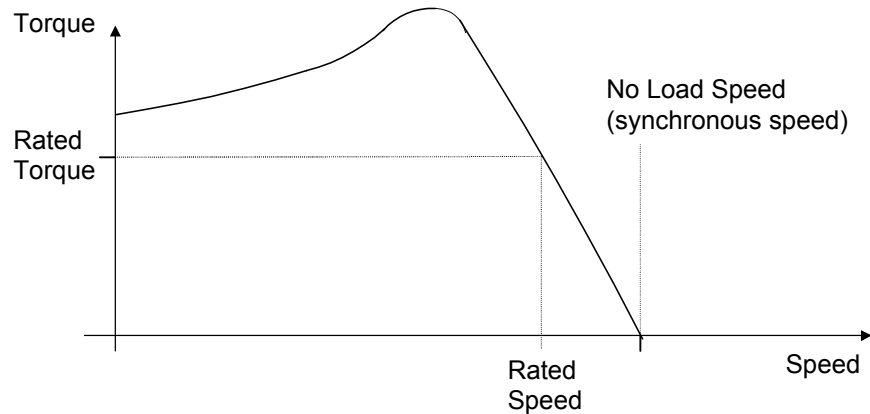

1-64 Programming Your Application

SPEED LOOP

Designed for SENSORLESS VEC Motor Control Mode.

This function block controls the speed of the motor by comparing the actual speed to the demanded speed, and applying more or less torque in response to the error.

Fixed Inputs and Outputs

Speed Demand

This is connected to the output of the SETPOINT SCALE function block.

Speed Feedback

When configured as SENSORLESS VEC, the speed feedback is calculated from the voltages and currents in the motor.

Torque Demand

The output of the SPEED LOOP function block is a torque demand. This torque demand is passed on to the TORQUE LIMIT function block, which causes the torque to be generated in the motor.

Speed Loop			
-	TOTL SPD DMD RPM	[1203]	0.00 RPM
-	TOTAL SPD DMD %	[1206]	0.00 %
-	SPEED ERROR	[1207]	0.00 %
-	TORQUE DEMAND	[1204]	0.00 %
** 20.00	[1187]	SPEED PROP GAIN	
** 100 ms	[1188]	SPEED INT TIME	
FALSE	[1189]	INT DEFEAT	
0.00 %	[1190]	SPEED INT PRESET	
3.0 ms	[1191]	SPEED DMD FILTER	
1.5 ms	[1192]	SPEED FBK FILTER	
0.00 %	[1193]	(AUX) TORQUE DMD	
110.00 %	[1200]	SPEED POS LIM	
-110.00 %	[1201]	SPEED NEG LIM	
FALSE	[1202]	TORQ CTRL MODE	

Parameter Descriptions

SPEED PROP GAIN F M SV *Range: 0.00 to 300.00*
SET\CTRL CL91

Sets the proportional gain of the loop.
Speed error (revolutions per second) x proportional gain = torque percent.

SPEED INT TIME F M SV *Range: 1 to 15000 ms*
SET\CTRL CL92

This is the integral time constant of the speed loop. A speed error which causes the proportional term to produce a torque demand T, will cause the integral term to also ramp up to a torque demand T after a time equal to "speed int time".

INT DEFEAT *Range: FALSE / TRUE*

When TRUE, the integral term does not operate.

SPEED INT PRESET *Range: -500.00 to 500.00 %*

The integral term will be preset to this value when the drive starts.

SPEED DMD FILTER *Range: 0.0 to 14.0 ms*

The speed demand is filtered to reduce ripple. The filter is first order with time constant equal to the value of this parameter.

SPEED FBK FILTER *Range: 0.0 to 15.0 ms*

The speed feedback is filtered to reduce ripple, such as that caused by low line count encoders. The filter is first order with time constant equal to the value of this parameter.

(AUX) TORQUE DMD *Range: -300.00 to 300.00 %*

When the drive is operating in speed control mode, the value of this parameter is added on to the torque demand produced by the speed loop PI. When the drive is operating in torque control mode (i.e. "TORQ CTRL MODE is TRUE) the speed loop PI does not operate and the torque demand becomes the value of this parameter..

SPEED POS LIM **F SV** SET\CTRL CL93 *Range: -110.00 to 110.00 %*

This sets the upper limit of the speed demand.

SPEED NEG LIM **F SV** SET\CTRL CL94 *Range: -110.00 to 110.00 %*

This sets the lower limit of the speed demand.

TORQ CTRL MODE *Range: FALSE / TRUE*

Selects between Speed Control mode and Torque Control mode. When TRUE, (Torque Control mode) the torque demand output from the speed loop block is the sum of the Direct Input plus the AUX TORQUE DMD parameter.

TOTL SPD DMD RPM *Range: —.xx rpm*

This shows the final values of the speed demand obtained after summing all sources. It is the value presented to the speed loop.

TOTAL SPD DMD % *Range: —.00 %*

This shows the final values of the speed demand obtained after summing all sources. It is the value presented to the speed loop.

SPEED ERROR *Range: —.00 %*

Shows the difference between the demanded speed and the actual speed.

TORQUE DEMAND *Range: —.00 %*

Shows the demanded motor torque as a percentage of rated motor torque.

Functional Description

The speed error (speed demand minus speed feedback) is calculated and processed via a proportional + integral (PI) controller. The output of the PI controller is a torque demand, which is passed directly to the torque control block.

The speed demand is derived from the Setpoint Scale block. When the drive is in SENSORLESS VEC mode, the speed feedback is calculated from the voltages and currents in the motor.

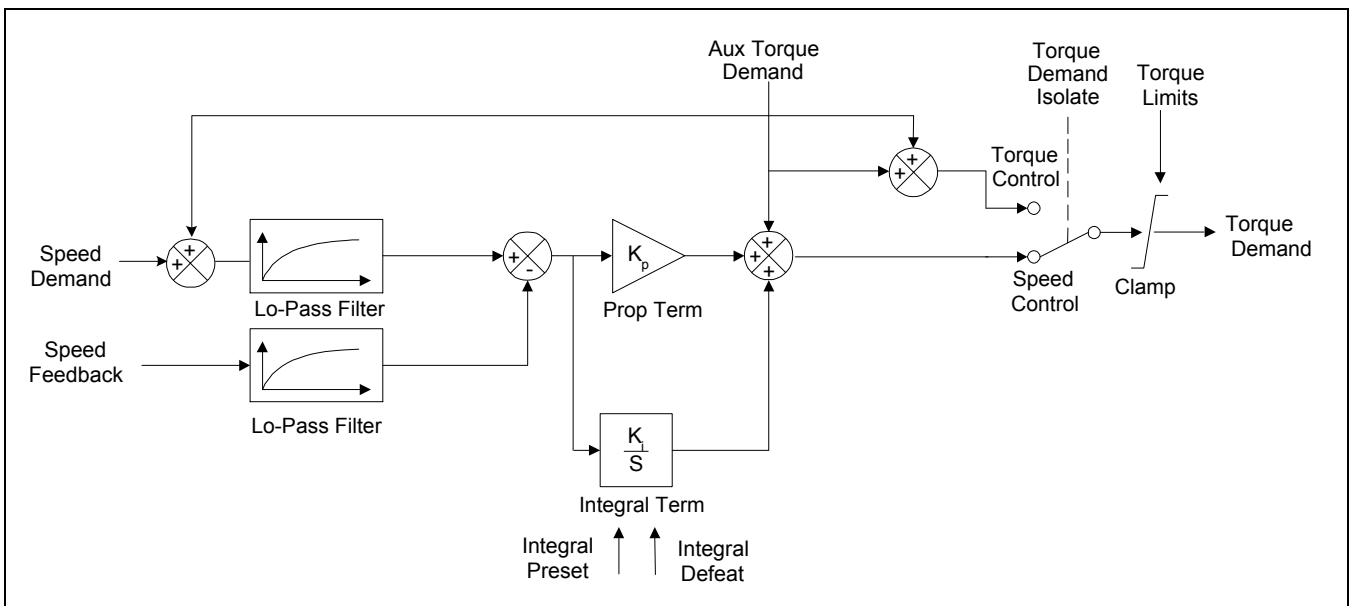

1-66 Programming Your Application

STABILISATION

Designed for VOLTS/Hz motor Control Mode.

Stabilisation
TRUE [128] ENABLE

Enabling this function reduces the problem of unstable running in induction motors. This can be experienced at approximately half full speed, and under low load conditions.

Parameter Descriptions

ENABLE

VF SET\CTRL CL05

Range: FALSE / TRUE

Enables (or disables) the stabilisation function.

STALL TRIP

The function block protects the motor from damage that may be caused by continuous operation beyond specification.

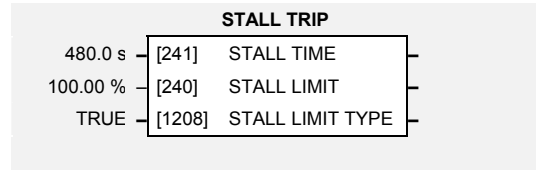

Parameter Descriptions

STALL LIMIT

This parameter is now obsolete.

Range: 50.00 to 150.00 %

STALL TIME

The time after which a stall condition will cause a trip.

Range: 0.1 to 3000.0 s

STALL LIMIT TYPE

 SET\CTRL CL84

Range: FALSE / TRUE

This parameter determines whether the stall trip operates on motor torque or motor current.

Enumerated Value : Stall Limit Type

FALSE : TORQUE

TRUE : CURRENT

Functional Description

If STALL LIMIT is set to TORQUE and the estimated load exceeds the active TORQUE LIMIT (refer to the TORQUE LIMIT function block) for a time greater than STALL TIME then the stall trip will become active. The timer is reset whenever the estimated load is less than the active Torque Limit.

Similarly, if the STALL LIMIT is set to CURRENT and the measured current exceeds the active Current Limit (i.e. the drive is in current limit) for a time greater than STALL TIME, the stall trip will become active. The timer is reset whenever the measured current is less than the active Current Limit.

Refer to the Installation Product Manual, Chapter 7 for a description of the trips supported by the drive.

1-68 Programming Your Application

TORQUE LIMIT

Designed for all Motor Control Modes.

This function block allows you to set the maximum level of motor rated torque which is allowed before torque limit action occurs.

If the estimated motor torque is greater than the ACTUAL POS LIM value, the motor speed is controlled to maintain the torque at this level. A similar situation occurs if the estimated motor torque is less than the ACTUAL NEG LIM value.

The torque limit function block has separate positive and negative torque limits. In addition, a symmetric main torque limit is also provided.

The lowest positive and negative torque limits (including any current limit or inverse time current limit action) is indicated in the ACTUAL POS LIM and ACTUAL NEG LIM diagnostic. These are the final limits used to limit motor torque.

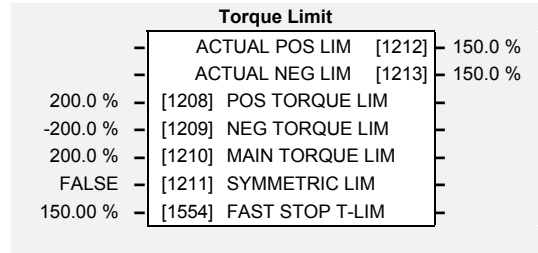

Parameter Descriptions

POS TORQUE LIM **SV** SETCTRL CL82 *Range: -500.0 to 500.0 %*

This parameter sets the maximum allowed level of positive motor torque.

NEG TORQUE LIM **SV** SETCTRL CL83 *Range: -500.0 to 500.0 %*

This parameter sets the maximum allowed level of negative motor torque

MAIN TORQUE LIM *Range: 0.0 to 300.0 %*

This parameter sets the symmetric limit on the maximum allowed motor torque.

SYMMETRIC LIM *Range: FALSE / TRUE/*

When TRUE, the NEG TORQUE LIM is forced to reflect the POS TORQUE LIM parameter.

FAST STOP T-LIM *Range: 0.00 to 300.00 %*

This parameter sets the torque limit used during a Fast Stop.

ACTUAL POS LIM *Range: —.0 %*

This indicates the final actual positive torque limit including any current limit or inverse time current limit action.

ACTUAL NEG LIM *Range: —.0 %*

This indicates the final actual negative torque limit including any current limit or inverse time current limit action.

TRIPS HISTORY

This function block records the last ten trips that caused the drive to stop.

To do this, it stores the value of the FIRST TRIP parameter, tag number 6, taken from the TRIPS STATUS function block.

TRIP 1 (NEWEST	[500]	NO TRIP
TRIP 2	[501]	NO TRIP
TRIP 3	[502]	NO TRIP
TRIP 4	[503]	NO TRIP
TRIP 5	[504]	NO TRIP
TRIP 6	[505]	NO TRIP
TRIP 7	[506]	NO TRIP
TRIP 8	[507]	NO TRIP
TRIP 9	[508]	NO TRIP
TRIP 10 (OLDEST	[509]	NO TRIP

Parameter Descriptions

TRIP 1 (NEWEST)

Range: Enumerated

Records the most recent trip that caused the drive to stop. The values that this (and the parameters below) may take are the same as tag number 6, FIRST TRIP, detailed in the TRIPS STATUS function block.

TRIP 2

Range: As above

Records the second most recent trip that caused the drive to stop.

TRIP 3

Range: As above

Records the third most recent trip that caused the drive to stop.

TRIP 4

Range: As above

Records the fourth most recent trip that caused the drive to stop.

TRIP 5

Range: As above

Records the fifth most recent trip that caused the drive to stop.

TRIP 6

Range: As above

Records the sixth most recent trip that caused the drive to stop.

TRIP 7

Range: As above

Records the seventh most recent trip that caused the drive to stop.

TRIP 8

Range: As above

Records the eighth most recent trip that caused the drive to stop.

TRIP 9

Range: As above

Records the ninth most recent trip that caused the drive to stop.

TRIP 10 (OLDEST)

Range: As above

Records the tenth most recent trip that caused the drive to stop.

Functional Description

This function block provides a view of the ten most recent trips that caused the drive to stop. Every time a new trip occurs this is entered as TRIP 1 (NEWEST and the other recorded trips are moved down. If more than ten trips have occurred since the drive was configured then only the ten most recent trips will be available for inspection.

These parameters are preserved through a power failure.

Refer to TRIPS STATUS, page 1-70 for an explanation of the four-digit codes.

1-70 Programming Your Application

TRIPS STATUS

The drive supports advanced and flexible trip logic to support monitoring of the drive itself, the motor and the load. This function block provides a view in to the current trip condition(s) and allows some trips to be disabled.

Refer to the "Trips and Fault Finding" chapter in the Installation Product Manual for trip descriptions.

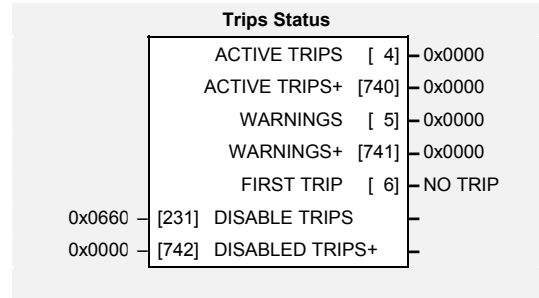

Parameter Descriptions

DISABLE TRIPS and DISABLE TRIPS+

Range: 0000 to FFFF

Indicates which trips have been disabled. Not all trips may be disabled, the DISABLED TRIPS mask is ignored for trips that cannot be disabled. See below for which trips may be disabled and how this parameter is formed.

ACTIVE TRIPS and ACTIVE TRIPS+

Range: 0000 to FFFF

Indicates all active trips, including user-disabled trips that are reporting a trip condition. The parameter returns a coded representation of the trip status. See below for a description of how this parameter is formed.

WARNINGS and WARNINGS+

Range: 0000 to FFFF

Indicates which conditions are likely to cause a trip, including potential conditions that may affect user-disabled trips. These parameters are a coded representation of the warning status. See below for a description of how this parameter is formed.

FIRST TRIP

Range: Enumerated – see table below

From when a trip occurs until that trip is reset, this parameter indicates the trip source. When several trips have occurred, this parameter indicates the first one that was detected.

Functional Description

The tables below show the possible parameter values for the FIRST TRIP, TRIPS HISTORY and the AUTO RESTART function blocks. Each trip has a unique, four-digit hexadecimal number as shown in the tables below.

ACTIVE TRIPS, WARNINGS, DISABLE TRIPS and TRIGGERS 1 (AUTO RESTART function block)					
ID	Trip Name (MMI 6901)	Trip Name (MMI 6511 & 6521)	Mask	Frames 1-3 User Disable	Frames C-F User Disable
0	NO TRIP		0x0000	N/A	N/A
1	OVERVOLTAGE	DCHI	0x0001		
2	UNDERVOLTAGE	DCLO	0x0002		
3	OVERCURRENT	OC	0x0004		
4	HEATSINK	HOT	0x0008		
5	EXTERNAL TRIP	ET	0x0010	✓	✓
6	INVERSE TIME	51E	0x0020	✓	✓
7	CURRENT LOOP	5LOOP	0x0040	✓	✓
8	MOTOR STALLED	55ELL	0x0080	✓	✓
9	ANIN FAULT	5E3	0x0100	✓	✓
10	BRAKE RESISTOR	5dbf	0x0200	✓	✓
11	BRAKE SWITCH	5db5	0x0400	✓	✓
12	DISPLAY/KEYPAD	5dl5P	0x0800	✓	✓
13	LOST COMMS	SCI	0x1000	✓	✓
14	CONTACTOR FBK	CNTC	0x2000	✓	✓
15	SPEED FEEDBACK	5SP	0x4000	✓	✓
16	■ AMBIENT TEMP	AOT	0x8000		

ACTIVE TRIPS+, WARNINGS+, DISABLE TRIPS+ and TRIGGERS 1+ (AUTO RESTART function block)					
ID	Trip Name (MMI 6901)	Trip Name (MMI 6511 & 6521)	Mask +	Frames 1-3 User Disable	Frames C-F User Disable
17	MOTOR OVERTEMP		0x0001	✓	✓
18	CURRENT LIMIT	I HI	0x0002		
19	<i>Trip 19 (Reserved)</i>	TR19	0x0004		
20	■ 24V FAILURE	T 6	0x0008	✓	✓
21	LOW SPEED OVER I	LSPD	0x0010		
22	10V FAULT	T 4	0x0020	✓	✓
23	<i>Trip 23 (Reserved)</i>	TR23	0x0040		
24	■ DESAT (OVER I)	SHRT	0x0080		
25	DC LINK RIPPLE	DCRP	0x0100		
26	■ BRAKE SHORT CCT	DBSC	0x0200		
27	OVERSPEED		0x0400	✓	✓
28	ANOUT FAULT	T 5	0x0800	✓	✓
29	DIGIO 1 (T9) FAULT	T 9	0x1000	✓	✓
30	DIGIO 2 (T10) FAULT	T 10	0x2000	✓	✓
31	UNKNOWN	TRIP	0x4000		
32	OTHER	TR32	0x8000		
33	◆ ■ ZERO I CAL	ICAL	0x8000	N/A	N/A
34	MAX SPEED LOW	ATN1	0x8000	N/A	N/A
35	MAIN VOLTS LOW	ATN2	0x8000	N/A	N/A
36	NOT AT SPEED	ATN3	0x8000	N/A	N/A
37	MAG CURRENT FAIL	ATN4	0x8000	N/A	N/A
38	NEGATIVE SLIP F	ATN5	0x8000	N/A	N/A
39	TR TOO LARGE	ATN6	0x8000	N/A	N/A
40	TR TOO SMALL	ATN7	0x8000	N/A	N/A
41	MAX RPM DATA ERR	ATN8	0x8000	N/A	N/A
42	LEAKGE L TIMEOUT	ATN9	0x8000	N/A	N/A
43	MOTOR TURNING ERR	ATNA	0x8000	N/A	N/A
44	MOTOR STALL ERR	ATNB	0x8000	N/A	N/A

- Not available on Frames 1-3
- ◆ Not available on Frames C-F

Enter FFFF to select/accept all, for example, entering FFFF for TRIGGERS 1 would make the drive auto-restart for trips with IDs from 1 to 16 inclusive.

Keypads (MMIs):

Trips shown as displays, i.e. , can be disabled using the keypads in the TRIPS menu. Other trips, as indicated, can be disabled over the Comms.



6901



6511



6521

1-72 Programming Your Application

Hexadecimal Representation of Trips

When more than one trip is to be represented at the same time then the trip codes are simply added together to form the value displayed. Within each digit, values between 10 and 15 are displayed as letters A to F

Decimal number	Display
10	A
11	B
12	C
13	D
14	E
15	F

For example referring to the tables above, if the ACTIVE TRIPS parameter is **02C8**, then this represents:

a “2” in digit 3

an “8” and a “4” in digit 2
(8+4 = 12, displayed as C)

an “8” in digit 1

This in turn represents the active trips BRAKE RESISTOR, MOTOR STALLED, CURRENT LOOP and HEATSINK, (an unlikely situation).

In the same way, the ACTIVE TRIPS + parameter displaying **02C8** would represent BRAKE SHORT CCT, DESAT (OVER I), *Trip 23 (Reserved)* and 24V FAILURE, (another unlikely situation).

Note: *The hexadecimal value is used over comms, however, pressing the M key whilst displaying the hexadecimal trip value will show the list of all trips and their current values.*

VALUE FUNCTION

The value function blocks can be configured to perform one of a number of functions upon a fixed number of inputs.

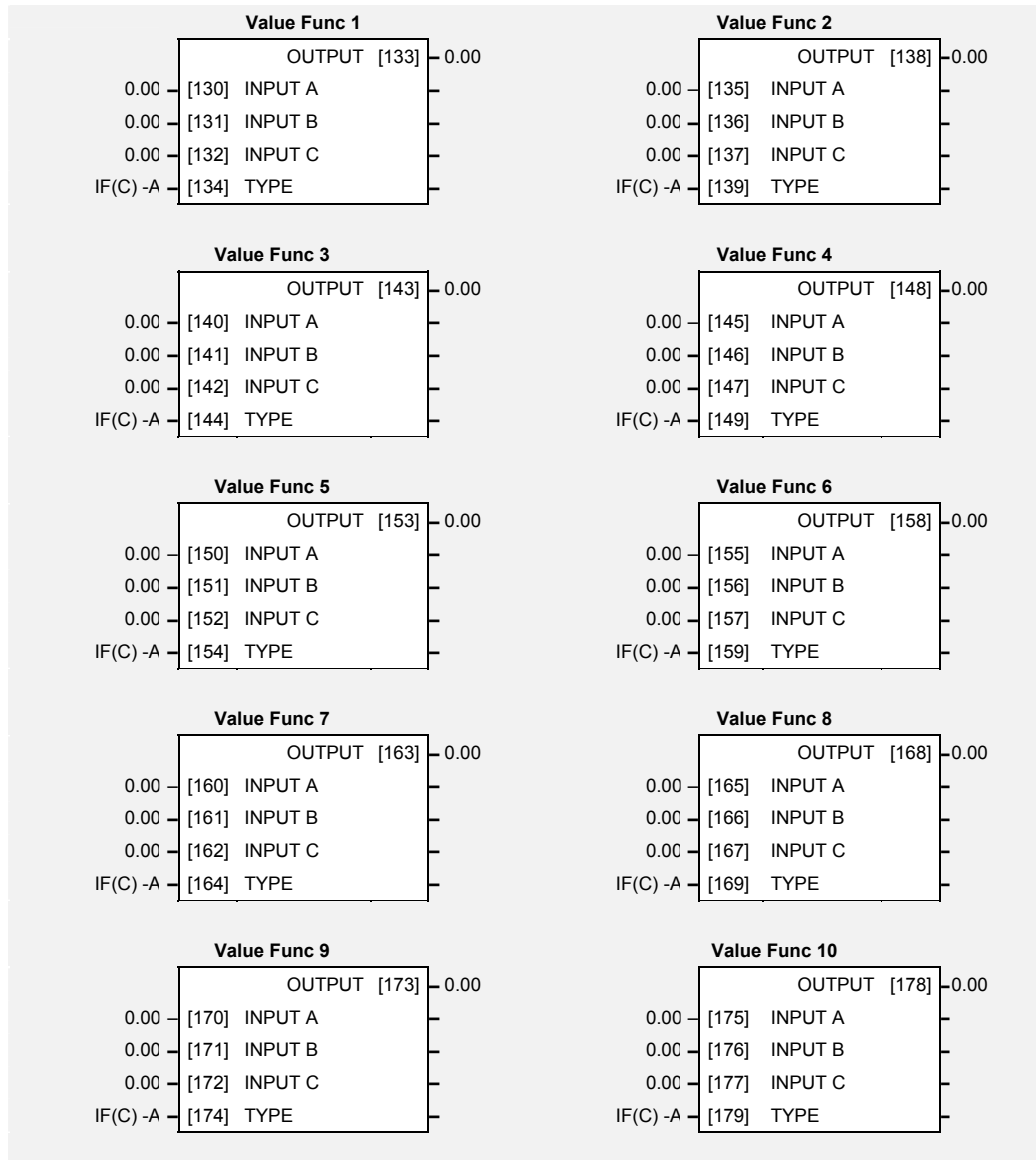

Boolean inputs and outputs are
 Outputs: FALSE = 0.00, TRUE = 0.01
 Inputs: $-0.005 < x < 0.005 = \text{FALSE}$, Else TRUE

Parameter Descriptions

INPUT A

General purpose input.

Range: -32768.00 to 32767.00

INPUT B

General purpose input.

Range: -32768.00 to 32767.00

INPUT C

General purpose input.

Range: -32768.00 to 32767.00

1-74 Programming Your Application

TYPE

Range: Enumerated - see below

The operation to be performed on the three inputs to produce the output value.

Enumerated Value : TYPE

- 0 : IF(C) -A
- 1 : ABS(A+B+C)
- 2 : SWITCH(A,B)
- 3 : (A*B)/C
- 4 : A+B+C
- 5 : A-B-C
- 6 : B<=A<=C
- 7 : A>B+/-C
- 8 : A>=B
- 9 : ABS(A)>B+/-C
- 10 : ABS(A)>=B
- 11 : A(1+B)
- 12 : IF(C) HOLD(A)
- 13 : BINARY DECODE
- 14 : ON DELAY
- 15 : OFF DELAY
- 16 : TIMER
- 17 : MINIMUM PULSE
- 18 : PULSE TRAIN
- 19 : WINDOW
- 20 : UP/DWN COUNTER
- 21 : (A*B)/C ROUND
- 22 : WINDOW NO HYST
- 23 : WIND A>=B,A<=C
- 24 : A<=B
- 25 : ((A*B)/100)+C
- 26 : MIN(A,B,C)
- 27 : MAX(A,B,C)
- 28 : PROFILE SQRT
- 29 : PROFILE LINEAR
- 30 : PROFILE x^2
- 31 : PROFILE x^3
- 32 : PROFILE x^4

OUTPUT

Range: —.xx

The result of performing the selected operation on the inputs.

Functional Description

OUTPUT is generated from the inputs according to the operation type selected. The output is always limited to be within the range -32768.00 to +32767.00.

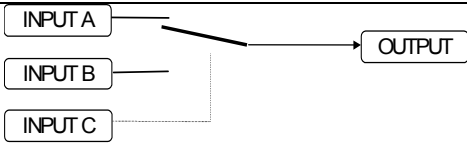
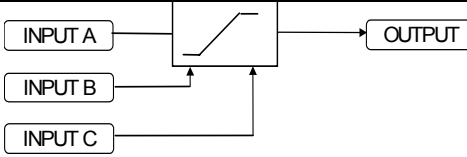
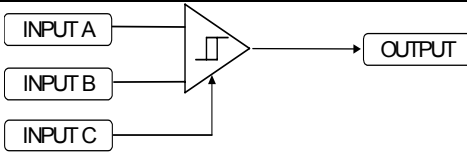
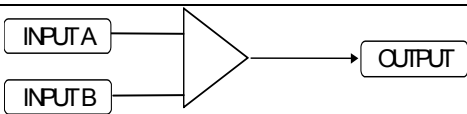
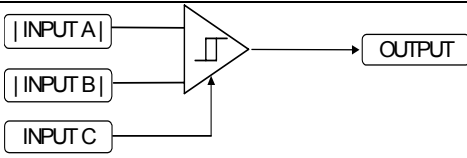
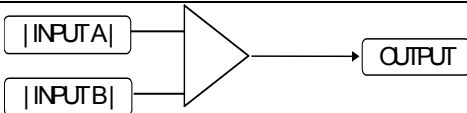
Operation	Description
IF(C) -A	If INPUT C is not zero the OUTPUT is minus INPUT A, otherwise the OUTPUT is the same as INPUT A.
ABS(A+B+C)	The OUTPUT is set to the absolute value of INPUT A + INPUT B + INPUT C.
SWITCH(A,B)	 <p>If INPUT C is zero the OUTPUT is set to INPUT A, otherwise the output is set to INPUT B</p>
(A*B)/C	The OUTPUT is set to (INPUT A * INPUT B) / (INPUT C). The algorithm compensates for the remainder term.
A+B+C	The OUTPUT is set to (INPUT A + INPUT B + INPUT C).
A-B-C	The OUTPUT is set to (INPUT A - INPUT B - INPUT C).
$B \leq A \leq C$	 <p>The OUTPUT is set to the value of INPUT A, limited to between a maximum value of INPUT C and a minimum value of INPUT B. If INPUT B is greater than INPUT C the output is undefined.</p>
$A > B \pm C$	 <p>The OUTPUT is TRUE if INPUT A is greater than INPUT B + INPUT C. The OUTPUT is FALSE if INPUT A is less than INPUT B - INPUT C.</p> <p>Otherwise the OUTPUT is unchanged. In this way the block acts as a simple comparator with a comparison level of INPUT B and a hysteresis band equal to +/- INPUT C.</p>
$A \geq B$	 <p>The OUTPUT is TRUE if INPUT A is greater than or equal to INPUT B, otherwise the OUTPUT is FALSE.</p>
$ABS(A) > ABS(B) \pm C$	 <p>The OUTPUT is TRUE if the magnitude of INPUT A is greater than or equal to the magnitude of INPUT B - INPUT C.</p> <p>The OUTPUT is FALSE if the magnitude of INPUT A is less than the magnitude of INPUT B + INPUT C. Otherwise the OUTPUT is unchanged. In this way the block acts as a magnitude comparator with a comparison level of INPUT B and a hysteresis band equal to +/- INPUT C.</p>
$ABS(A) > ABS(B)$	 <p>The OUTPUT is TRUE if the magnitude of INPUT A is greater than or equal to the magnitude of INPUT B, otherwise the OUTPUT is FALSE.</p>
$A(1+B)$	The OUTPUT is set to INPUT A + (INPUT A * INPUT B / 100.00).

1-76 Programming Your Application

Operation	Description
IF(C) HOLD A	If INPUT C is zero, the OUTPUT is set to INPUT A, otherwise the OUTPUT is unchanged. On powering up the drive, the output will be pre-loaded with the last saved value of input B.

BINARY DECODE		The OUTPUT is set according to which of the INPUTs are non-zero.			
INPUT C	INPUT B	INPUT A	OUTPUT		
0	0	0	0.00		
0	0	≠0	1.00		
0	≠0	0	2.00		
0	≠0	≠0	3.00		
≠0	0	0	4.00		
≠0	0	≠0	5.00		
≠0	≠0	0	6.00		
≠0	≠0	≠0	7.00		

In the above table, ≠0 indicates that the corresponding input is not zero.

ON DELAY

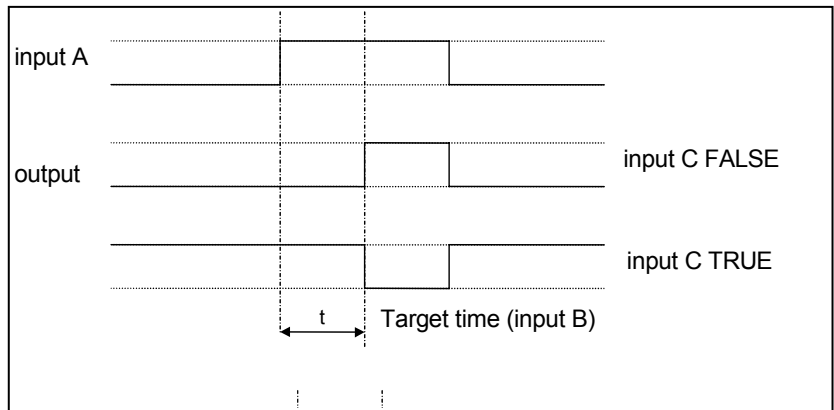

A programmable delay between receiving and outputting a Boolean TRUE signal.

INPUT A becoming TRUE starts the delay timer. INPUT B sets the duration of the delay in seconds (1 = 1 second). At the end of the duration, OUTPUT becomes TRUE unless INPUT A has reverted to FALSE. Setting INPUT C to TRUE (≠0) inverts the output.

OFF DELAY

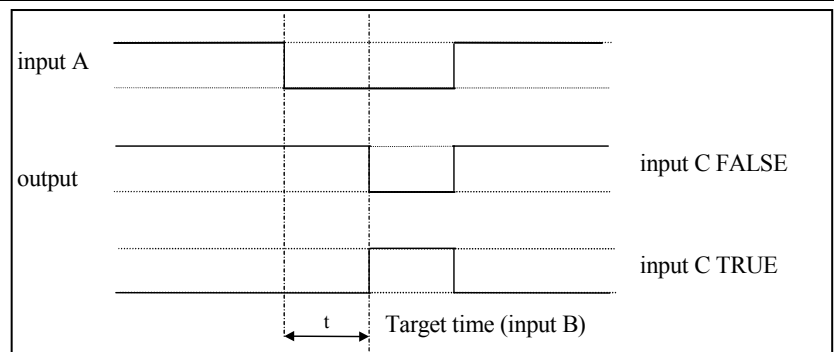

A programmable delay between receiving and outputting a Boolean FALSE signal.

INPUT A becoming FALSE starts the delay timer. INPUT B sets the duration of the delay in seconds (1 = 1 second). Setting INPUT C to TRUE (≠0) inverts the output. At the end of the duration, OUTPUT becomes FALSE unless INPUT A has reverted to TRUE.

Operation	Description
-----------	-------------

TIMER

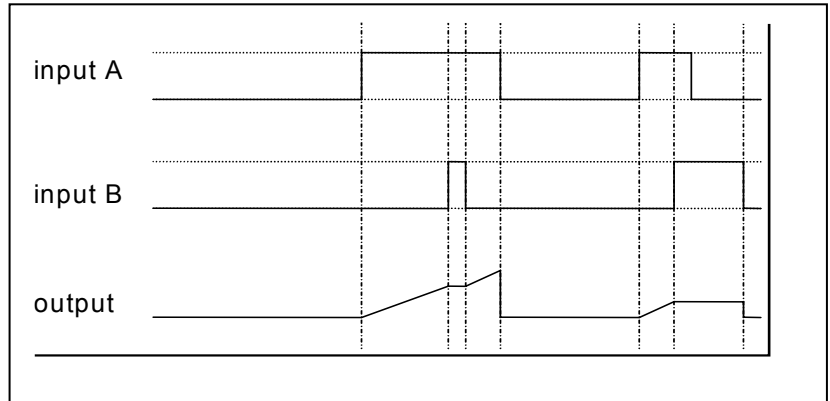

Times the period elapsed from when INPUT A is set TRUE and held TRUE, to when INPUT B becomes TRUE.

OUTPUT is the duration of the timer in seconds (1 = 1 second), starting from zero. If INPUT B is TRUE, the value for OUTPUT is held until INPUT B is released. If on release INPUT A is still TRUE, the timer will continue from the held value. Setting INPUT A and INPUT B to FALSE resets the timer.

INPUT C is not used.

MINIMUM PULSE

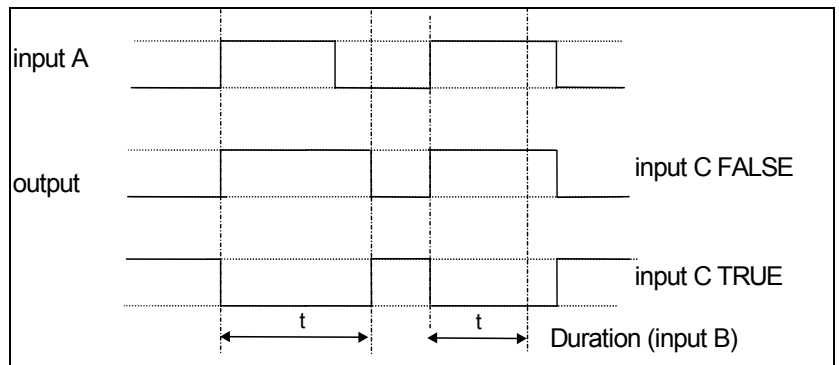

Creates an output of adjustable minimum time when INPUT A is TRUE. (INPUT A is assumed to be a sequence of TRUE pulses and FALSE off periods.)

INPUT B sets the length of the minimum pulse required in seconds (1 = 1 second). INPUT C inverts the output when TRUE. The duration of the pulse is *at least* the period set by INPUT B.

1-78 Programming Your Application

Operation	Description
PULSE TRAIN	

Creates a pulsed FALSE / TRUE output of programmable frequency.

INPUT A enables the pulse train when TRUE, disables when FALSE.

INPUT B sets the length of the *on* part of the pulse in seconds (1 = 1 second). INPUT C sets the length of the *off* part of the pulse in seconds (1 = 1 second).

WINDOW	

This function outputs TRUE when INPUT A is within a programmable range, and FALSE otherwise.

INPUT B sets the threshold of the window to be monitored. INPUT C defines the range of the window around the threshold. When the value of INPUT A is inside the window, the window expands by 0.01 to avoid flutter on output if noisy, i.e. if INPUT B = 5 and INPUT C = 4 then the range is 3 to 7, expanded to 2.5 to 7.5 when the value if INPUT A is inside the window.

If INPUT C is set to zero, the output will only be TRUE if INPUT A is exactly equal to INPUT B (this is fulfilled in the default condition when inputs A, B & C are all zero)

If INPUT C is set to a negative value, its absolute value defines the window range, and the output is inverted.

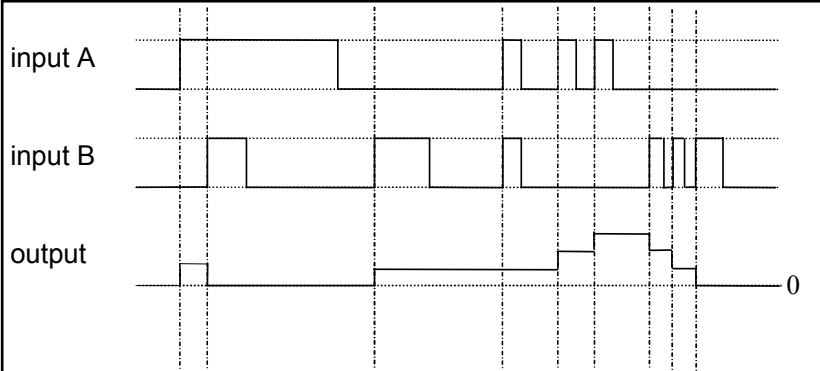
Operation	Description
UP/DOWN COUNTER	 <p>INPUT A provides a rising edge trigger to increment the output count by one.</p> <p>INPUT B provides a rising edge trigger to decrement the output count by one.</p> <p>INPUT C holds the output at zero.</p> <p>The output starts at zero. The output is limited at ± 300.00.</p>
$(A*B)/C$ ROUND	The OUTPUT is set to $(\text{INPUT A} * \text{INPUT B}) / (\text{INPUT C})$. This is the same as $(A*B)/C$ (enumerated value 3) except that the result is rounded.
WINDOW NO HYST	This is the same as WINDOW (enumerated value 19) except that there is no hysteresis when inside the 'window'. Thus, from the diagram given in WINDOW, if INPUT B = 5 and INPUT C = 4 then the range is 3 to 7.
WIND $A \geq B, A \leq C$	This is the same as WINDOW (enumerated value 19) except that instead of setting hysteresis, the upper and lower limits are set independently. The lower limit is INPUT B, the upper limit is INPUT C. OUTPUT is True if $B \leq A \leq C$.
$A \leq B$	The OUTPUT is True if INPUT A is less than or equal to INPUT B, otherwise OUTPUT is False.
$((A*B)/100)+C$	OUTPUT is set to $(\text{INPUT A} * \text{INPUT B})/100 + \text{INPUT C}$.
MIN(A,B,C)	The OUTPUT is set to the minimum value of INPUT A, B and C.
MAX(A,B,C)	The OUTPUT is set to the maximum value of INPUT A, B and C.
PROFILE SQRT	OUTPUT = INPUT B + (INPUT C - INPUT B) x square root A.
PROFILE LINEAR	OUTPUT = INPUT B + (INPUT C - INPUT B) x INPUT A
PROFILE x^2	OUTPUT = INPUT B + (INPUT C - INPUT B) x (INPUT A) ²
PROFILE x^3	OUTPUT = INPUT B + (INPUT C - INPUT B) x (INPUT A) ³
PROFILE x^4	OUTPUT = INPUT B + (INPUT C - INPUT B) x (INPUT A) ⁴

1-80 Programming Your Application

VOLTAGE CONTROL

Designed for VOLTS/Hz motor Control Mode.

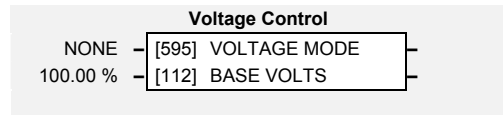

This function block allows the motor output volts to be controlled in the presence of dc link voltage variations. This is achieved by controlling the level of PWM modulation as a function of measured dc link volts. The dc link volts may vary either due to supply variations or regenerative braking by the motor.

Three control modes are available, None, Fixed and Automatic.

Parameter Descriptions

VOLTAGE MODE  *SETCTRL CL06* *Range: Enumerated - see below*

Set to NONE, no attempt is made to control the PWM modulation depth for variations in dc link voltage.

Set to FIXED, the drive's output volts are maintained, regardless of variations in the dc link voltage. The drive's product code sets the default value for demanded maximum output voltage (see MOTOR VOLTS below).

Set to AUTOMATIC, the voltage is controlled as above, but the output voltage is allowed to rise smoothly as dc link volts vary. This allows the motor to be overfluxed during deceleration, thereby increasing braking performance.

Enumerated Value : VOLTAGE MODE

- 0 : NONE
- 1 : FIXED
- 2 : AUTOMATIC

BASE VOLTS *Range: 0.00 to 115.47 %*

This parameter directly scales the output of the voltage control function block, thus allowing further scaling of the drive output volts if required.

Refer also to "Normal/Heavy Duty Selection", page 1-82.

ZERO SPEED

This function block detects when the speed is at or close to zero. HYSTERESIS and THRESHOLD are user-definable.

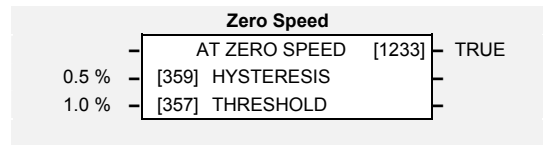

Parameter Descriptions

HYSTERESIS

Range: 0.0 to 300.0 %

Provides a hysteresis band about which the outputs are stable.

IF the hysteresis value is \geq to the Threshold
 THEN the level is set to 2 x the hysteresis value and the Off level is set to zero,
 ELSE the On level = Threshold + Hysteresis and the Off level = Threshold - Hysteresis.

THRESHOLD

Range: 0.0 to 300.0 %

The nominal level below which the outputs are set.

AT ZERO SPEED

Range: FALSE / TRUE

TRUE when at zero speed feedback, as defined by THRESHOLD and HYSTERESIS.

IF (abs(speed feedback)) > On Level at zero speed = FALSE
 ELSE if (abs(speed feedback)) \leq Off Level at zero speed = TRUE
 ELSE at zero speed is unchanged

Functional Description

Note: The speed feedback used is the speed demand added to all trims, (such as those due to stabilisation or slip compensation).

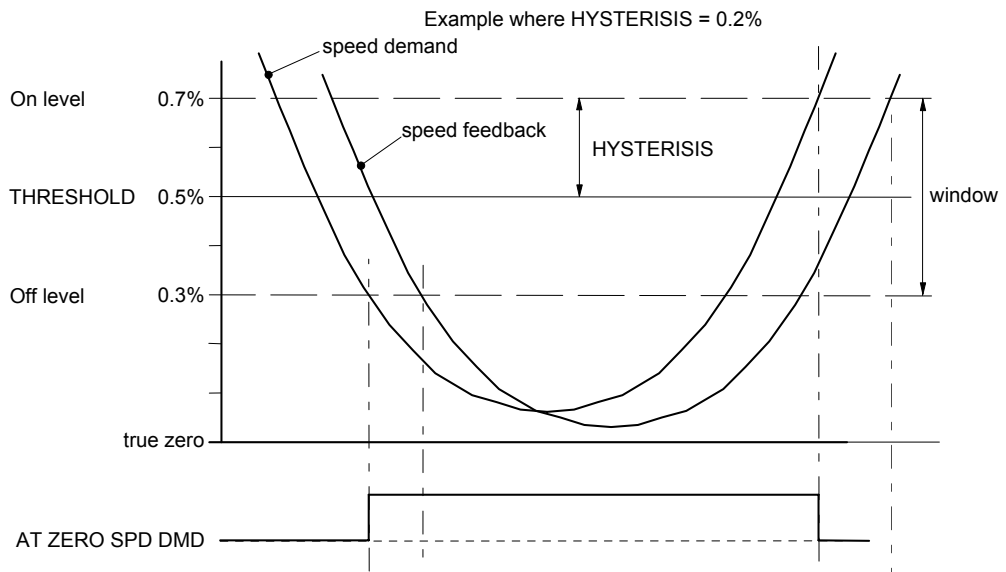

1-82 Programming Your Application

Normal/Heavy Duty Selection

When selecting or de-selecting Normal Duty, several parameter values and their limits are modified.

The parameters affected are shown in the table below.

Change from HEAVY DUTY to NORMAL DUTY			
Function Block	Parameter	Set to	Note
INVERSE TIME	Max Overload Level	110.0 %	Internal Parameter
CURRENT LIMIT	CURRENT LIMIT	110.0 %	High Limit set 110.0 %
VOLTAGE CONTROL	BASE VOLTS	115.47 %	High Limit 115.47 %

Change from NORMAL DUTY to HEAVY DUTY			
Function Block	Parameter	Set to	Note
INVERSE TIME	Max Overload Level	150.0 %	Internal Parameter
CURRENT LIMIT	CURRENT LIMIT	150.0 %	High Limit set 150.0 %
VOLTAGE CONTROL	BASE VOLTS	100.0 %	High Limit 115.47 %

Chapter 2 PARAMETER SPECIFICATION

The headings for the Tag No. table are described below.

Tag	A numeric identification of the parameter.
Pref	A numeric identification of the parameter
MMI Name	The parameter name as it appears on the MMI (keypad).
CELITE Name	The parameter name as it appears in Parker SSD Drives' own programming tool, DSE.
Function Block	The function block under which the parameter is stored in CELITE.
Type	REAL Floating point value INT Integer value BOOL A Boolean (bit) representing FALSE or TRUE ENUM An enumerated value representing a selection WORD 16 Bit hexadecimal number TAG Requires the Tag Number of a parameter
Range	This varies with parameter type: REAL, INT The upper and lower limits of the parameter BOOL 0 = FALSE, 1 = TRUE ENUM A list of possible selections for that parameter WORD 0000 to FFFF (hexadecimal) TAG The upper and lower limits of the parameter
ID	Serial Communications Mnemonic: Refer to Chapter 3: "Serial Communications"

In the MMI Parameters table the following Notes apply:

- F** Parameter only visible on MMI in detailed menus mode.
- M** Parameter is a Motor parameter, not reset on changing Application.
- VF** Parameter is only visible when in VF motor control mode.
- SV** Parameter is only visible when in SV motor control mode.
- (0) Modbus decimal point is xxxx.
- (1) Modbus decimal point is xxx.x
- (2) Modbus decimal point is xx.xx
- (3) Modbus decimal point is x.xxx

2-2 Parameter Specification

Specification Table: Tag Number Order

TAG	Pref	CELITE Name	MMI Name	Function Block Name	Range	Type	ID
4	50.03	ACTIVE TRIPS		TRIPS STATUS	Output	WORD	04
5	50.05	WARNINGS		TRIPS STATUS	Output	WORD	05
6	50.07	FIRST TRIP		TRIPS STATUS	0 : NO TRIP 1 : OVERVOLTAGE 2 : UNDERVOLTAGE 3 : OVERCURRENT 4 : HEATSINK 5 : EXTERNAL TRIP 6 : INVERSE TIME 7 : CURRENT LOOP 8 : MOTOR STALLED 9 : ANIN FAULT 10 : BRAKE RESISTOR 11 : BRAKE SWITCH 12 : DISPLAY / KEYPAD 13 : LOST COMMS 14 : CONTACTOR FBK 15 : SPEED FEEDBACK 16 : AMBIENT TEMP 17 : MOTOR OVERTEMP 18 : CURRENT LIMIT 19 : SHORT CIRCUIT 20 : 24V FAILURE 21 : LOW SPEED OVER I 22 : 10V FAULT 23 : ENCODER 1 FAULT 24 : DESAT (OVER I) 25 : VDC RIPPLE 26 : BRAKE SHORT CCT 27 : OVERSPEED 28 : ANOUT FAULT 29 : DIG IO 1 FAULT 30 : DIG IO 2 FAULT 31 : UNKNOWN 32 : OTHER 33 : ZERO I CAL 34 : MAX SPEED LOW 35 : MAINS VOLTS LOW 36 : NOT AT SPEED 37 : MAG CURRENT FAIL 38 : NEGATIVE SLIP F 39 : TR TOO LARGE 40 : TR TOO SMALL 41 : MAX RPM DATA ERR 42 : MOTOR TURNING ERR 43 : MOTOR STALL ERR 44 : LEAKGE L TIMEOUT	ENUM	06
8	21.01	PASSWORD	PAR 99	MMI ACCESS	0x0000 to 0xFFFF	WORD	08
13	10.03	TYPE	SET\IN IP13	ANALOG INPUT 1	0 : 0..10 V 1 : 0...5 V	ENUM	0d
14	10.01	SCALE	SET\IN IP11	ANALOG INPUT 1	-300.00 to 300.00	REAL	0e
15	10.02	OFFSET	SET\IN IP12	ANALOG INPUT 1	-300.00 to 300.00	REAL	0f
16	10.05	VALUE	SET\IN IPA1	ANALOG INPUT 1	Output (2)	REAL	0g
22	11.03	TYPE	SET\IN IP23	ANALOG INPUT 2	0 : 0..10 V 1 : 0...5 V 2 : 0..20 mA 3 : 4..20 mA	ENUM	0m
23	11.01	SCALE	SET\IN IP21	ANALOG INPUT 2	-300.00 to 300.00	REAL	0n
24	11.02	OFFSET	SET\IN IP22	ANALOG INPUT 2	-300.00 to 300.00	REAL	0o
25	11.06	VALUE	SET\IN IPA2	ANALOG INPUT 2	Output (2)	REAL	0p
26	11.04	BREAK VALUE		ANALOG INPUT 2	-100.0 to 100.0 (2)	REAL	0q
28	57.15	SETPOINT		FLYCATCHING	Output	REAL	0s
30	13.1.1	INVERT	SET\IN IP01	DIGITAL INPUT 1 (Terminal 7)	0 to 1	BOOL	0u
31	13.1.2	VALUE	SET\IN IPD1	DIGITAL INPUT 1 (Terminal 7)	Output	BOOL	0v
32	57.06	SEARCH BOOST		FLYCATCHING	0.00 to 50.00	REAL	0w
33	13.2.1	INVERT	SET\IN IP02	DIGITAL INPUT 2 (Terminal 8)	0 to 1	BOOL	0x
34	13.2.2	VALUE	SET\IN IPD2	DIGITAL INPUT 2 (Terminal 8)	Output	BOOL	0y
36	13.3.1	INVERT	SET\IN IP03	DIGITAL INPUT 3 (Terminal 9)	0 to 1	BOOL	10
37	13.3.2	VALUE	SET\IN IPD3	DIGITAL INPUT 3 (Terminal 9)	Output	BOOL	11
39	13.4.1	INVERT	SET\IN IP04	DIGITAL INPUT 4 (Terminal 10)	0 to 1	BOOL	13
40	13.4.2	VALUE	SET\IN IPD4	DIGITAL INPUT 4 (Terminal 10)	Output	BOOL	14

Parameter Specification 2-3

TAG	Pref	CELITE Name	MMI Name	Function Block Name	Range	Type	ID
42	13.5.1	INVERT	SET\IN IP05	DIGITAL INPUT 5 (Terminal 11)	0 to 1	BOOL	16
43	13.5.2	VALUE	SET\IN IPD5	DIGITAL INPUT 5 (Terminal 11)	Output	BOOL	17
45	12.01	VALUE	SET\OUT OP05	ANALOG OUTPUT	-300.0 to 300.0 (2)	REAL	19
46	12.02	SCALE	SET\OUT OP02	ANALOG OUTPUT	-300.00 to 300.00	REAL	1a
47	12.03	OFFSET	SET\OUT OP03	ANALOG OUTPUT	-300.00 to 300.00	REAL	1b
48	12.04	ABSOLUTE	SET\OUT OP04	ANALOG OUTPUT	0 to 1	BOOL	1c
50	27.01	NORMAL DUTY	PAR 12	FEEDBACKS	0 to 1	BOOL	1e
51	14.1.2	INVERT		DIGITAL OUTPUT 1 (Terminal 9)	0 to 1	BOOL	1f
52	14.1.1	VALUE		DIGITAL OUTPUT 1 (Terminal 9)	0 to 1	BOOL	1g
54	14.2.2	INVERT	SET\OUT OP22	DIGITAL OUTPUT 2 (Terminal 10)	0 to 1	BOOL	1i
55	14.2.1	VALUE	SET\OUT OP23	DIGITAL OUTPUT 2 (Terminal 10)	0 to 1	BOOL	1j
57	23.03	MAX SPEED	PAR 2	REFERENCE	7.5 to 240.0	REAL	1l
60	34.01	ENABLE		SLEW RATE LIMIT	0 to 1	BOOL	1o
61	34.03	DECEL LIMIT		SLEW RATE LIMIT	1.0 to 1200.0	REAL	1p
62	34.02	ACCEL LIMIT		SLEW RATE LIMIT	1.0 to 1200.0	REAL	1q
64	35.03	MOTOR CURRENT	PAR 6	MOTOR DATA	0.01 to 999.99 (1)	REAL	1s
65	35.04	MAG CURRENT	SET\CTRL CL14	MOTOR DATA	0.01 to 999.99 (1)	REAL	1t
66	27.03	MOTOR CURRENT %		FEEDBACKS	Output	REAL	1u
67	27.04	MOTOR CURRENT A	DIAG 4	FEEDBACKS	Output	REAL	1v
70	27.11	TORQUE FEEDBACK	SET\SETP ST41	FEEDBACKS	Output	REAL	1y
73	27.12	FIELD FEEDBACK		FEEDBACKS	Output	REAL	21
74	70.01	CUSTOM MENU 1	PAR 901	CUSTOM MENU	0 to 1655	TAG	22
75	27.02	DC LINK VOLTS	DIAG 3	FEEDBACKS	Output	REAL	23
77	36.04	BRAKE RESISTANCE	SET\SETP ST32	DYNAMIC BRAKING	1 to 1000	INT	25
78	36.05	BRAKE POWER	SET\SETP ST33	DYNAMIC BRAKING	0.1 to 510.0	REAL	26
79	36.06	1SEC OVER RATING	SET\SETP ST34	DYNAMIC BRAKING	1 to 40	INT	27
80	36.01	ENABLE	SET\SETP ST31	DYNAMIC BRAKING	0 to 1	BOOL	28
81	36.03	BRAKING		DYNAMIC BRAKING	Output	BOOL	29
82	39.01	ENABLE	SET\CTRL CL04	SLIP COMP	0 to 1	BOOL	2a
83	35.05	NAMEPLATE RPM	SET\CTRL CL02	MOTOR DATA	0.1 to 30000.0 (0)	REAL	2b
84	35.06	MOTOR POLES	SET\CTRL CL11	MOTOR DATA	0 : 2 POLE 1 : 4 POLE 2 : 6 POLE 3 : 8 POLE 4 : 10 POLE 5 : 12 POLE	ENUM	2c
85	39.02	MOTORING LIMIT		SLIP COMP	0.0 to 600.0	REAL	2d
86	39.03	REGEN LIMIT		SLIP COMP	0.0 to 600.0	REAL	2e
98	25.01	RANDOM PATTERN		PATTERN GEN	0 to 1	BOOL	2q
100	25.02	DEFLUX DELAY		PATTERN GEN	0.1 to 10.0	REAL	2s
102	18.01	GROUP ID (GID)		COMMS PORTS	0 to 7	INT	2u
103	18.02	COMMS ADDRESS	SET\SERL SE03	COMMS PORTS	0 to 255	INT	2v
104	33.01	V/F SHAPE	PAR 11	FLUXING	0 : LINEAR LAW 1 : FAN LAW	ENUM	2w
107	33.02	FIXED BOOST	PAR 13	FLUXING	0.00 to 25.00	REAL	2z
108	33.03	AUTO BOOST	SET\CTRL CL08	FLUXING	0.00 to 25.00	REAL	30
110	66.05	SPEED SCALE	SET\ENC EN05	ENCODER	0.00 to 300.00	REAL	32
111	66.06	SPEED	SET\ENC EN06	ENCODER	Output (0)	REAL	33
112	53.02	BASE VOLTS		VOLTAGE CONTROL	0.00 to 115.47	REAL	34
117	18.08	RS485 PROTOCOL	SET\SERL SE09	COMMS PORTS	0 : AUTOMATIC 1 : KEYPAD 2 : EIBISYNC ASCII 3 : MODBUS 4 : FIELDBUS	ENUM	39
119	35.14	STATOR RES	SET\CTRL CL17	MOTOR DATA	0.0000 to 250.0000 (2)	REAL	3b
120	35.15	LEAKAGE INDUC	SET\CTRL CL18	MOTOR DATA	0.00 to 300.00 (1)	REAL	3c
121	35.16	MUTUAL INDUC	SET\CTRL CL19	MOTOR DATA	0.00 to 3000.00 (1)	REAL	3d
124	35.09	MOTOR CONNECTION	SET\CTRL CL16	MOTOR DATA	0 : DELTA 1 : STAR	ENUM	3g
126	43.08	FINAL STOP RATE		REFERENCE STOP	12. to 4800.	REAL	3i

2-4 Parameter Specification

TAG	Pref	CELITE Name	MMI Name	Function Block Name	Range	Type	ID
127	22.01	ENABLED KEYS	SET\SETP ST52	DISPLAY/KEYPAD	0x0000 to 0xFFFF	WORD	3j
128	31.01	ENABLE	SET\CTRL CLO5	STABILISATION	0 to 1	BOOL	3k
129	18.09	SWITCH OP PORT	SET\SERL SE10	COMMS PORTS	0 to 1	BOOL	3l
130	15.1.1	INPUT A		VALUE FUNC 1	-32768.00 to 32767.00	REAL	3m
131	15.1.2	INPUT B		VALUE FUNC 1	-32768.00 to 32767.00	REAL	3n
132	15.1.3	INPUT C		VALUE FUNC 1	-32768.00 to 32767.00	REAL	3o
133	15.1.5	OUTPUT		VALUE FUNC 1	Output	REAL	3p
134	15.1.4	TYPE		VALUE FUNC 1	0 : IF(C) -A 1 : ABS(A+B+C) 2 : SWITCH(A,B) 3 : (A*B)/C 4 : A+B+C 5 : A-B-C 6 : B<=A<=C 7 : A>B+/-C 8 : A>=B 9 : ABS(A)>B+/-C 10 : ABS(A)>=B 11 : A(1+B) 12 : IF(C) HOLD(A) 13 : BINARY DECODE 14 : ON DELAY 15 : OFF DELAY 16 : TIMER 17 : MINIMUM PULSE 18 : PULSE TRAIN 19 : WINDOW 20 : UP/DWN COUNTER 21 : (A*B)/C ROUND 22 : WINDOW NO HYST 23 : WIND A>=B,A<=C 24 : A<=B 25 : ((A*B)/100)+C 26 : MIN(A,B,C) 27 : MAX(A,B,C) 28 : PROFILE SQRT 29 : PROFILE LINEAR 30 : PROFILE x^2 31 : PROFILE x^3 32 : PROFILE x^4	ENUM	3q
135	15.2.1	INPUT A		VALUE FUNC 2	-32768.00 to 32767.00	REAL	3r
136	15.2.2	INPUT B		VALUE FUNC 2	-32768.00 to 32767.00	REAL	3s
137	15.2.3	INPUT C		VALUE FUNC 2	-32768.00 to 32767.00	REAL	3t
138	15.2.5	OUTPUT		VALUE FUNC 2	Output	REAL	3u
139	15.2.4	TYPE		VALUE FUNC 2	As VALUE FUNC 1	ENUM	3v
140	15.3.1	INPUT A		VALUE FUNC 3	-32768.00 to 32767.00	REAL	3w
141	15.3.2	INPUT B		VALUE FUNC 3	-32768.00 to 32767.00	REAL	3x
142	15.3.3	INPUT C		VALUE FUNC 3	-32768.00 to 32767.00	REAL	3y
143	15.3.5	OUTPUT		VALUE FUNC 3	Output	REAL	3z
144	15.3.4	TYPE		VALUE FUNC 3	As VALUE FUNC 1	ENUM	40
145	15.4.1	INPUT A		VALUE FUNC 4	-32768.00 to 32767.00	REAL	41
146	15.4.2	INPUT B		VALUE FUNC 4	-32768.00 to 32767.00	REAL	42
147	15.4.3	INPUT C		VALUE FUNC 4	-32768.00 to 32767.00	REAL	43
148	15.4.5	OUTPUT		VALUE FUNC 4	Output	REAL	44
149	15.4.4	TYPE		VALUE FUNC 4	As VALUE FUNC 1	ENUM	45
150	15.5.1	INPUT A		VALUE FUNC 5	-32768.00 to 32767.00	REAL	46
151	15.5.2	INPUT B		VALUE FUNC 5	-32768.00 to 32767.00	REAL	47
152	15.5.3	INPUT C		VALUE FUNC 5	-32768.00 to 32767.00	REAL	48
153	15.5.5	OUTPUT		VALUE FUNC 5	Output	REAL	49
154	15.5.4	TYPE		VALUE FUNC 5	As VALUE FUNC 1	ENUM	4a
155	15.6.1	INPUT A		VALUE FUNC 6	-32768.00 to 32767.00	REAL	4b
156	15.6.2	INPUT B		VALUE FUNC 6	-32768.00 to 32767.00	REAL	4c
157	15.6.3	INPUT C		VALUE FUNC 6	-32768.00 to 32767.00	REAL	4d
158	15.6.5	OUTPUT		VALUE FUNC 6	Output	REAL	4e
159	15.6.4	TYPE		VALUE FUNC 6	As VALUE FUNC 1	ENUM	4f
160	15.7.1	INPUT A		VALUE FUNC 7	-32768.00 to 32767.00	REAL	4g
161	15.7.2	INPUT B		VALUE FUNC 7	-32768.00 to 32767.00	REAL	4h
162	15.7.3	INPUT C		VALUE FUNC 7	-32768.00 to 32767.00	REAL	4i
163	15.7.5	OUTPUT		VALUE FUNC 7	Output	REAL	4j

Parameter Specification 2-5

TAG	Pref	CELITE Name	MMI Name	Function Block Name	Range	Type	ID
164	15.7.4	TYPE		VALUE FUNC 7	As VALUE FUNC 1	ENUM	4k
165	15.8.1	INPUT A		VALUE FUNC 8	-32768.00 to 32767.00	REAL	4l
166	15.8.2	INPUT B		VALUE FUNC 8	-32768.00 to 32767.00	REAL	4m
167	15.8.3	INPUT C		VALUE FUNC 8	-32768.00 to 32767.00	REAL	4n
168	15.8.5	OUTPUT		VALUE FUNC 8	Output	REAL	4o
169	15.8.4	TYPE		VALUE FUNC 8	As VALUE FUNC 1	ENUM	4p
170	15.9.1	INPUT A		VALUE FUNC 9	-32768.00 to 32767.00	REAL	4q
171	15.9.2	INPUT B		VALUE FUNC 9	-32768.00 to 32767.00	REAL	4r
172	15.9.3	INPUT C		VALUE FUNC 9	-32768.00 to 32767.00	REAL	4s
173	15.9.5	OUTPUT		VALUE FUNC 9	Output	REAL	4t
174	15.9.4	TYPE		VALUE FUNC 9	As VALUE FUNC 1	ENUM	4u
175	15.10.1	INPUT A		VALUE FUNC 10	-32768.00 to 32767.00	REAL	4v
176	15.10.2	INPUT B		VALUE FUNC 10	-32768.00 to 32767.00	REAL	4w
177	15.10.3	INPUT C		VALUE FUNC 10	-32768.00 to 32767.00	REAL	4x
178	15.10.5	OUTPUT		VALUE FUNC 10	Output	REAL	4y
179	15.10.4	TYPE		VALUE FUNC 10	As VALUE FUNC 1	ENUM	4z
180	16.1.1	INPUT A		LOGIC FUNC 1	0 to 1	BOOL	50
181	16.1.2	INPUT B		LOGIC FUNC 1	0 to 1	BOOL	51
182	16.1.3	INPUT C		LOGIC FUNC 1	0 to 1	BOOL	52
183	16.1.5	OUTPUT		LOGIC FUNC 1	Output	BOOL	53
184	16.1.4	TYPE		LOGIC FUNC 1	0 : NOT(A) 1 : AND(A,B,C) 2 : NAND(A,B,C) 3 : OR(A,B,C) 4 : NOR(A,B,C) 5 : XOR(A,B) 6 : 0-1 EDGE(A) 7 : 1-0 EDGE(A) 8 : AND(A,B,!C) 9 : OR(A,B,!C) 10 : S FLIP-FLOP 11 : R FLIP-FLOP 12 : LATCH 13 : SWITCH	ENUM	54
185	16.2.1	INPUT A		LOGIC FUNC 2	0 to 1	BOOL	55
186	16.2.2	INPUT B		LOGIC FUNC 2	0 to 1	BOOL	56
187	16.2.3	INPUT C		LOGIC FUNC 2	0 to 1	BOOL	57
188	16.2.5	OUTPUT		LOGIC FUNC 2	Output	BOOL	58
189	16.2.4	TYPE		LOGIC FUNC 2	As LOGIC FUNC 1	ENUM	59
190	16.3.1	INPUT A		LOGIC FUNC 3	0 to 1	BOOL	5a
191	16.3.2	INPUT B		LOGIC FUNC 3	0 to 1	BOOL	5b
192	16.3.3	INPUT C		LOGIC FUNC 3	0 to 1	BOOL	5c
193	16.3.5	OUTPUT		LOGIC FUNC 3	Output	BOOL	5d
194	16.3.4	TYPE		LOGIC FUNC 3	As LOGIC FUNC 1	ENUM	5e
195	16.4.1	INPUT A		LOGIC FUNC 4	0 to 1	BOOL	5f
196	16.4.2	INPUT B		LOGIC FUNC 4	0 to 1	BOOL	5g
197	16.4.3	INPUT C		LOGIC FUNC 4	0 to 1	BOOL	5h
198	16.4.5	OUTPUT		LOGIC FUNC 4	Output	BOOL	5i
199	16.4.4	TYPE		LOGIC FUNC 4	As LOGIC FUNC 1	ENUM	5j
200	16.5.1	INPUT A		LOGIC FUNC 5	0 to 1	BOOL	5k
201	16.5.2	INPUT B		LOGIC FUNC 5	0 to 1	BOOL	5l
202	16.5.3	INPUT C		LOGIC FUNC 5	0 to 1	BOOL	5m
203	16.5.5	OUTPUT		LOGIC FUNC 5	Output	BOOL	5n
204	16.5.4	TYPE		LOGIC FUNC 5	As LOGIC FUNC 1	ENUM	5o
205	16.6.1	INPUT A		LOGIC FUNC 6	0 to 1	BOOL	5p
206	16.6.2	INPUT B		LOGIC FUNC 6	0 to 1	BOOL	5q
207	16.6.3	INPUT C		LOGIC FUNC 6	0 to 1	BOOL	5r
208	16.6.5	OUTPUT		LOGIC FUNC 6	Output	BOOL	5s
209	16.6.4	TYPE		LOGIC FUNC 6	As LOGIC FUNC 1	ENUM	5t
210	16.7.1	INPUT A		LOGIC FUNC 7	0 to 1	BOOL	5u
211	16.7.2	INPUT B		LOGIC FUNC 7	0 to 1	BOOL	5v
212	16.7.3	INPUT C		LOGIC FUNC 7	0 to 1	BOOL	5w
213	16.7.5	OUTPUT		LOGIC FUNC 7	Output	BOOL	5x

2-6 Parameter Specification

TAG	Pref	CELITE Name	MMI Name	Function Block Name	Range	Type	ID
214	16.7.4	TYPE		LOGIC FUNC 7	As LOGIC FUNC 1	ENUM	5y
215	16.8.1	INPUT A		LOGIC FUNC 8	0 to 1	BOOL	5z
216	16.8.2	INPUT B		LOGIC FUNC 8	0 to 1	BOOL	60
217	16.8.3	INPUT C		LOGIC FUNC 8	0 to 1	BOOL	61
218	16.8.5	OUTPUT		LOGIC FUNC 8	Output	BOOL	62
219	16.8.4	TYPE		LOGIC FUNC 8	As LOGIC FUNC 1	ENUM	63
220	16.9.1	INPUT A		LOGIC FUNC 9	0 to 1	BOOL	64
221	16.9.2	INPUT B		LOGIC FUNC 9	0 to 1	BOOL	65
222	16.9.3	INPUT C		LOGIC FUNC 9	0 to 1	BOOL	66
223	16.9.5	OUTPUT		LOGIC FUNC 9	Output	BOOL	67
224	16.9.4	TYPE		LOGIC FUNC 9	As LOGIC FUNC 1	ENUM	68
225	16.10.1	INPUT A		LOGIC FUNC 10	0 to 1	BOOL	69
226	16.10.2	INPUT B		LOGIC FUNC 10	0 to 1	BOOL	6a
227	16.10.3	INPUT C		LOGIC FUNC 10	0 to 1	BOOL	6b
228	16.10.5	OUTPUT		LOGIC FUNC 10	Output	BOOL	6c
229	16.10.4	TYPE		LOGIC FUNC 10	As LOGIC FUNC 1	ENUM	6d
230	22.02	DISP 1 VERSION		DISPLAY/KEYPAD	Output	WORD	6e
231	50.01	DISABLE TRIPS	SET\TRIP LOOP	TRIPS STATUS	0x0000 to 0xFFFF	WORD	6f
234	54.02	EXTERNAL TRIP		IO TRIPS	0 to 1	BOOL	6i
240	56.02	STALL LIMIT		STALL TRIP	50.00 to 150.00	REAL	6o
241	56.01	STALL TIME		STALL TRIP	0.1 to 3000.0	REAL	6p
242	35.10	POWER FACTOR		MOTOR DATA	0.50 to 0.99	REAL	6q
243	23.06	TRIM IN LOCAL		REFERENCE	0 to 1	BOOL	6r
244	42.01	RAMP TYPE	SET\SETP ST03	REFERENCE RAMP	0 : LINEAR 1 : S	ENUM	6s
245	23.01	REMOTE SETPOINT		REFERENCE	-110.0 to 110.0 (2)	REAL	6t
246	20.01	SETPOINT	PAR 8	REFERENCE JOG	-100.0 to 100.0 (2)	REAL	6u
247	23.13	LOCAL SETPOINT		REFERENCE	-100.0 to 100.0 (2)	REAL	6v
248	23.02	SPEED TRIM		REFERENCE	-110.0 to 110.0 (2)	REAL	6w
249	23.07	REMOTE REVERSE		REFERENCE	0 to 1	BOOL	6x
250	23.15	LOCAL REVERSE		REFERENCE	Output	BOOL	6y
251	23.16	LOCAL MIN SPEED	SET\SETP ST51	REFERENCE	0.0 to 100.0	REAL	6z
252	23.04	MAX SPEED CLAMP		REFERENCE	0.0 to 110.0 (2)	REAL	70
253	23.05	MIN SPEED CLAMP		REFERENCE	-110.0 to 0.0 (2)	REAL	71
254	23.10	SPEED SETPOINT	DIAG 2	REFERENCE	Output (2)	REAL	72
255	23.09	SPEED DEMAND		REFERENCE	Output (2)	REAL	73
256	23.12	REVERSE		REFERENCE	Output	BOOL	74
257	41.06	REMOTE REF		LOCAL CONTROL	Output	BOOL	75
258	42.02	ACCEL TIME	PAR 4	REFERENCE RAMP	0.0 to 3000.0	REAL	76
259	42.03	DECEL TIME	PAR 5	REFERENCE RAMP	0.0 to 3000.0	REAL	77
260	42.06	HOLD		REFERENCE RAMP	0 to 1	BOOL	78
261	20.02	ACCEL TIME	SET\SETP ST01	REFERENCE JOG	0.0 to 3000.0	REAL	79
262	20.03	DECEL TIME	SET\SETP ST02	REFERENCE JOG	0.0 to 3000.0	REAL	7a
263	43.02	STOP TIME		REFERENCE STOP	0.0 to 600.0	REAL	7b
264	43.07	FAST STOP TIME		REFERENCE STOP	0.0 to 600.0	REAL	7c
265	41.02	REF MODES		LOCAL CONTROL	0 : LOCAL/REMOTE 1 : LOCAL ONLY 2 : REMOTE ONLY	ENUM	7d
266	43.03	STOP ZERO SPEED		REFERENCE STOP	0.0 to 100.0 (2)	REAL	7e
270	19.07	COMMS REF		COMMS CONTROL	Output	BOOL	7i
272	19.08	COMMS STATUS		COMMS CONTROL	Output	WORD	7k
273	19.09	COMMS COMMAND		COMMS CONTROL	Output	WORD	7l
274	24.24	HEALTHY		SEQUENCING LOGIC	Output	BOOL	7m
275	43.06	FAST STOP LIMIT		REFERENCE STOP	0.0 to 3000.0	REAL	7n
276	24.06	DRIVE ENABLE		SEQUENCING LOGIC	0 to 1	BOOL	7o
277	24.07	NOT FAST STOP		SEQUENCING LOGIC	0 to 1	BOOL	7p
278	24.08	NOT COAST STOP		SEQUENCING LOGIC	0 to 1	BOOL	7q
279	43.01	RUN STOP MODE	PAR 9	REFERENCE STOP	0 : RAMPED 1 : COAST 2 : DC INJECTION	ENUM	7r
280	24.04	JOG		SEQUENCING LOGIC	0 to 1	BOOL	7s

Parameter Specification 2-7

TAG	Pref	CELITE Name	MMI Name	Function Block Name	Range	Type	ID
281	41.04	SEQ DIRECTION		LOCAL CONTROL	0 to 1	BOOL	7f
282	24.10	REM TRIP RESET		SEQUENCING LOGIC	0 to 1	BOOL	7u
283	24.12	POWER UP START		SEQUENCING LOGIC	0 to 1	BOOL	7v
284	43.04	STOP DELAY		REFERENCE STOP	0.0 to 30.0 (3)	REAL	7w
285	24.14	RUNNING		SEQUENCING LOGIC	Output	BOOL	7x
286	24.17	OUTPUT CONTACTOR		SEQUENCING LOGIC	Output	BOOL	7y
287	24.20	READY		SEQUENCING LOGIC	Output	BOOL	7z
288	24.18	SWITCH ON ENABLE		SEQUENCING LOGIC	Output	BOOL	80
289	24.13	TRIPPED		SEQUENCING LOGIC	Output	BOOL	81
290	24.11	TRIP RST BY RUN		SEQUENCING LOGIC	0 to 1	BOOL	82
291	24.01	RUN FORWARD		SEQUENCING LOGIC	0 to 1	BOOL	83
292	24.02	RUN REVERSE		SEQUENCING LOGIC	0 to 1	BOOL	84
293	24.03	NOT STOP		SEQUENCING LOGIC	0 to 1	BOOL	85
294	24.09	REMOTE REVERSE		SEQUENCING LOGIC	0 to 1	BOOL	86
295	19.06	COMMS SEQ		COMMS CONTROL	Output	BOOL	87
296	24.23	REMOTE REV OUT		SEQUENCING LOGIC	Output	BOOL	88
297	41.05	REMOTE SEQ		LOCAL CONTROL	Output	BOOL	89
298	41.01	SEQ MODES		LOCAL CONTROL	0 : LOCAL/REMOTE 1 : LOCAL ONLY 2 : REMOTE ONLY	ENUM	8a
299	41.03	POWER UP MODE		LOCAL CONTROL	0 : LOCAL 1 : REMOTE 2 : AUTOMATIC	ENUM	8b
300	19.01	REMOTE COMMS SEL	SET\SERL SE01	COMMS CONTROL	0 to 1	BOOL	8c
301	24.22	SEQUENCER STATE		SEQUENCING LOGIC	0 : START DISABLED 1 : START ENABLED 2 : SWITCHED ON 3 : READY 4 : ENABLED 5 : F-STOP ACTIVE 6 : TRIP ACTIVE 7 : TRIPPED	ENUM	8d
302	24.15	JOGGING		SEQUENCING LOGIC	Output	BOOL	8e
303	24.16	STOPPING		SEQUENCING LOGIC	Output	BOOL	8f
304	43.05	FAST STOP MODE		REFERENCE STOP	0 : RAMPED 1 : COAST	ENUM	8g
305	24.21	SYSTEM RESET		SEQUENCING LOGIC	Output	BOOL	8h
306	24.19	SWITCHED ON		SEQUENCING LOGIC	Output	BOOL	8i
307	19.02	REMOTE SEQ MODES		COMMS CONTROL	0 : TERMINALS/COMMS 1 : TERMINALS ONLY 2 : COMMS ONLY	ENUM	8j
308	19.03	REMOTE REF MODES		COMMS CONTROL	0 : TERMINALS/COMMS 1 : TERMINALS ONLY 2 : COMMS ONLY	ENUM	8k
309	19.04	COMMS TIMEOUT	SET\SERL SE02	COMMS CONTROL	0.0 to 600.0	REAL	8l
325	44.08	OUTPUT		RAISE/LOWER	Output	REAL	91
326	44.03	RAMP TIME	PAR 401	RAISE/LOWER	0.0 to 600.0	REAL	92
327	44.01	RAISE INPUT		RAISE/LOWER	0 to 1	BOOL	93
328	44.02	LOWER INPUT		RAISE/LOWER	0 to 1	BOOL	94
329	44.05	MIN VALUE	PAR 403	RAISE/LOWER	-100.00 to 100.00	REAL	95
330	44.04	MAX VALUE	PAR 402	RAISE/LOWER	-100.00 to 100.00	REAL	96
331	44.06	RESET VALUE	PAR 404	RAISE/LOWER	-100.00 to 100.00	REAL	97
332	44.07	RESET		RAISE/LOWER	0 to 1	BOOL	98
335	45.04	OUTPUT		MINIMUM SPEED	Output (2)	REAL	9b
336	45.01	INPUT		MINIMUM SPEED	-300.0 to 300.0 (2)	REAL	9c
337	45.02	MINIMUM	PAR 3	MINIMUM SPEED	-100.0 to 100.0 (2)	REAL	9d
338	45.03	MODE		MINIMUM SPEED	0 : PROP. W/MIN 1 : LINEAR	ENUM	9e
340	55.01	INPUT		SKIP FREQUENCIES	-300.00 to 300.00	REAL	9g
341	55.02	BAND 1	SET\SETP ST12	SKIP FREQUENCIES	0.0 to 60.0	REAL	9h
342	55.03	FREQUENCY 1	SET\SETP ST11	SKIP FREQUENCIES	0.0 to 240.0	REAL	9i
343	55.05	FREQUENCY 2	SET\SETP ST13	SKIP FREQUENCIES	0.0 to 240.0	REAL	9j
346	55.06	OUTPUT		SKIP FREQUENCIES	Output	REAL	9m
347	17.1.2	INPUT 0	PAR 301	PRESET 1	-32768.00 to 32767.00	REAL	9n

2-8 Parameter Specification

TAG	Pref	CELITE Name	MMI Name	Function Block Name	Range	Type	ID
348	17.1.3	INPUT 1	PAR 302	PRESET 1	-32768.00 to 32767.00	REAL	9o
349	17.1.4	INPUT 2	PAR 303	PRESET 1	-32768.00 to 32767.00	REAL	9p
350	17.1.5	INPUT 3	PAR 304	PRESET 1	-32768.00 to 32767.00	REAL	9q
351	17.1.6	INPUT 4	PAR 305	PRESET 1	-32768.00 to 32767.00	REAL	9r
352	17.1.7	INPUT 5	PAR 306	PRESET 1	-32768.00 to 32767.00	REAL	9s
353	17.1.8	INPUT 6	PAR 307	PRESET 1	-32768.00 to 32767.00	REAL	9t
354	17.1.9	INPUT 7	PAR 308	PRESET 1	-32768.00 to 32767.00	REAL	9u
355	17.1.1	SELECT INPUT		PRESET 1	0 : INPUT 0 1 : INPUT 1 2 : INPUT 2 3 : INPUT 3 4 : INPUT 4 5 : INPUT 5 6 : INPUT 6 7 : INPUT 7	ENUM	9v
356	17.1.10	OUTPUT 1		PRESET 1	Output	REAL	9w
357	49.02	THRESHOLD		ZERO SPEED	0.0 to 300.0 (2)	REAL	9x
359	49.01	HYSTERISIS		ZERO SPEED	0.0 to 300.0 (2)	REAL	9z
365	28.01	CURRENT LIMIT	SET\CTRL CL81	CURRENT LIMIT	0.00 to 150.00	REAL	a5
371	70.02	CUSTOM MENU 2	PAR 902	CUSTOM MENU	0 to 1655	TAG	ab
372	17.1.11	OUTPUT 2		PRESET 1	Output	REAL	ac
373	17.2.11	OUTPUT 2		PRESET 2	Output	REAL	ad
374	17.3.11	OUTPUT 2		PRESET 3	Output	REAL	ae
380	17.2.2	INPUT 0		PRESET 2	-32768.00 to 32767.00	REAL	ak
381	17.2.3	INPUT 1		PRESET 2	-32768.00 to 32767.00	REAL	al
382	17.2.4	INPUT 2		PRESET 2	-32768.00 to 32767.00	REAL	am
383	17.2.5	INPUT 3		PRESET 2	-32768.00 to 32767.00	REAL	an
384	17.2.6	INPUT 4		PRESET 2	-32768.00 to 32767.00	REAL	ao
385	17.2.7	INPUT 5		PRESET 2	-32768.00 to 32767.00	REAL	ap
386	17.2.8	INPUT 6		PRESET 2	-32768.00 to 32767.00	REAL	aq
387	17.2.9	INPUT 7		PRESET 2	-32768.00 to 32767.00	REAL	ar
388	17.2.1	SELECT INPUT		PRESET 2	0 : INPUT 0 1 : INPUT 1 2 : INPUT 2 3 : INPUT 3 4 : INPUT 4 5 : INPUT 5 6 : INPUT 6 7 : INPUT 7	ENUM	as
389	17.2.10	OUTPUT 1		PRESET 2	Output	REAL	at
390	17.3.2	INPUT 0		PRESET 3	-32768.00 to 32767.00	REAL	au
391	17.3.3	INPUT 1		PRESET 3	-32768.00 to 32767.00	REAL	av
392	17.3.4	INPUT 2		PRESET 3	-32768.00 to 32767.00	REAL	aw
393	17.3.5	INPUT 3		PRESET 3	-32768.00 to 32767.00	REAL	ax
394	17.3.6	INPUT 4		PRESET 3	-32768.00 to 32767.00	REAL	ay
395	17.3.7	INPUT 5		PRESET 3	-32768.00 to 32767.00	REAL	az
396	17.3.8	INPUT 6		PRESET 3	-32768.00 to 32767.00	REAL	b0
397	17.3.9	INPUT 7		PRESET 3	-32768.00 to 32767.00	REAL	b1
398	17.3.1	SELECT INPUT		PRESET 3	0 : INPUT 0 1 : INPUT 1 2 : INPUT 2 3 : INPUT 3 4 : INPUT 4 5 : INPUT 5 6 : INPUT 6 7 : INPUT 7	ENUM	b2
399	17.3.10	OUTPUT 1		PRESET 3	Output	REAL	b3
500	51.01	TRIP 1 (NEWEST)		TRIPS HISTORY	As TRIPS STATUS	ENUM	dw
501	51.02	TRIP 2		TRIPS HISTORY	As TRIPS STATUS	ENUM	dx
502	51.03	TRIP 3		TRIPS HISTORY	As TRIPS STATUS	ENUM	dy
503	51.04	TRIP 4		TRIPS HISTORY	As TRIPS STATUS	ENUM	dz
504	51.05	TRIP 5		TRIPS HISTORY	As TRIPS STATUS	ENUM	e0
505	51.06	TRIP 6		TRIPS HISTORY	As TRIPS STATUS	ENUM	e1
506	51.07	TRIP 7		TRIPS HISTORY	As TRIPS STATUS	ENUM	e2
507	51.08	TRIP 8		TRIPS HISTORY	As TRIPS STATUS	ENUM	e3
508	51.09	TRIP 9		TRIPS HISTORY	As TRIPS STATUS	ENUM	e4

Parameter Specification 2-9

TAG	Pref	CELITE Name	MMI Name	Function Block Name	Range	Type	ID
509	51.10	TRIP 10 (OLDEST)		TRIPS HISTORY	As TRIPS STATUS	ENUM	e5
510	17.4.2	INPUT 0		PRESET 4	-32768.00 to 32767.00	REAL	e6
511	17.4.3	INPUT 1		PRESET 4	-32768.00 to 32767.00	REAL	e7
512	17.4.4	INPUT 2		PRESET 4	-32768.00 to 32767.00	REAL	e8
513	17.4.5	INPUT 3		PRESET 4	-32768.00 to 32767.00	REAL	e9
514	17.4.6	INPUT 4		PRESET 4	-32768.00 to 32767.00	REAL	ea
515	17.4.7	INPUT 5		PRESET 4	-32768.00 to 32767.00	REAL	eb
516	17.4.8	INPUT 6		PRESET 4	-32768.00 to 32767.00	REAL	ec
517	17.4.9	INPUT 7		PRESET 4	-32768.00 to 32767.00	REAL	ed
518	17.4.1	SELECT INPUT		PRESET 4	0 : INPUT 0 1 : INPUT 1 2 : INPUT 2 3 : INPUT 3 4 : INPUT 4 5 : INPUT 5 6 : INPUT 6 7 : INPUT 7	ENUM	ee
519	17.4.10	OUTPUT 1		PRESET 4	Output	REAL	ef
520	17.4.11	OUTPUT 2		PRESET 4	Output	REAL	eg
565	66.01	MODE	SET\ENC EN01	ENCODER	0 : QUADRATURE 1 : CLOCK/DIR 2 : CLOCK	ENUM	fp
566	66.04	LINES	SET\ENC EN04	ENCODER	100 to 10000	INT	fq
567	66.03	INVERT	SET\ENC EN03	ENCODER	0 to 1	BOOL	fr
568	27.07	SPEED FBK REV/S		FEEDBACKS	Output	REAL	fs
569	27.06	SPEED FBK RPM		FEEDBACKS	Output (1)	REAL	ft
570	57.01	VHz ENABLE	SET\CTRL CL03	FLYCATCHING	0 to 1	BOOL	fu
571	57.03	START MODE		FLYCATCHING	0 : ALWAYS 1 : TRIP OR POWER UP 2 : TRIP	ENUM	fv
572	57.04	SEARCH MODE		FLYCATCHING	0 : BIDIRECTIONAL 1 : UNIDIRECTION	ENUM	fw
573	57.05	SEARCH VOLTS		FLYCATCHING	0.00 to 100.00	REAL	fx
574	57.07	SEARCH TIME		FLYCATCHING	0.1 to 60.0	REAL	fy
575	57.08	MIN SEARCH SPEED		FLYCATCHING	0.0 to 500.0	REAL	fz
576	57.14	ACTIVE		FLYCATCHING	Output	BOOL	g0
577	30.02	FREQUENCY		INJ BRAKING	1.0 to 240.0	REAL	g1
578	30.03	I-LIM LEVEL		INJ BRAKING	50.0 to 150.0 (2)	REAL	g2
579	30.04	DC PULSE		INJ BRAKING	0.0 to 100.0	REAL	g3
580	30.05	FINAL DC PULSE		INJ BRAKING	0.0 to 10.0	REAL	g4
581	30.06	DC LEVEL		INJ BRAKING	0.0 to 25.0	REAL	g5
582	30.07	TIMEOUT		INJ BRAKING	0.0 to 600.0	REAL	g6
583	30.09	ACTIVE		INJ BRAKING	Output	BOOL	g7
584	69.01	ON LOAD		BRAKE CONTROL	0.00 to 150.00	REAL	g8
585	69.02	ON FREQUENCY		BRAKE CONTROL	0.0 to 500.0	REAL	g9
586	69.03	OFF FREQUENCY		BRAKE CONTROL	0.0 to 500.0	REAL	ga
587	69.04	ON HOLD TIME		BRAKE CONTROL	0.00 to 60.00	REAL	gb
588	69.05	OFF HOLD TIME		BRAKE CONTROL	0.00 to 60.00	REAL	gc
589	69.06	RELEASE		BRAKE CONTROL	Output	BOOL	gd
590	69.07	HOLD		BRAKE CONTROL	Output	BOOL	ge
591	25.03	DRIVE FREQUENCY	DIAG 1	PATTERN GEN	Output (2)	REAL	gf
595	53.01	VOLTAGE MODE	SET\CTRL CL06	VOLTAGE CONTROL	0 : NONE 1 : FIXED 2 : AUTOMATIC	ENUM	gj
598	47.17	OUTPUT		MULTIPLEXER	Output	WORD	gm
599	48.01	INPUT		DEMULTIPLEXER	0x0000 to 0xFFFF	WORD	gn
603	63.01	ENABLE	SET\CTRL CL21	AUTOTUNE	0 to 1	BOOL	gr
604	63.09	ACTIVE		AUTOTUNE	Output	BOOL	gs
608	40.05	PENDING		AUTO RESTART	Output	BOOL	gw
609	40.03	TRIGGERS 1	SET\SETP ST23	AUTO RESTART	0x0000 to 0xFFFF	WORD	gx
612	40.01	ATTEMPTS	SET\SETP ST21	AUTO RESTART	0 to 10	INT	h0
613	40.02	ATTEMPT DELAY 1	SET\SETP ST22	AUTO RESTART	0.0 to 600.0	REAL	h1
614	40.07	ATTEMPTS LEFT		AUTO RESTART	Output	INT	h2
615	40.08	TIME LEFT		AUTO RESTART	Output	REAL	h3

2-10 Parameter Specification

TAG	Pref	CELITE Name	MMI Name	Function Block Name	Range	Type	ID
616	40.06	RESTARTING		AUTO RESTART	Output	BOOL	h4
617	46.02	FEEDBACK		PID	-300.00 to 300.00	REAL	h5
618	46.04	FEEDBACK GAIN	PAR 505	PID	-10.00 to 10.00	REAL	h6
619	46.14	ERROR	PAR 508	PID	Output	REAL	h7
620	24.25	FAN RUNNING		SEQUENCING LOGIC	Output	BOOL	h8
621	65.01	LEVEL	SET\SETP ST42	AT LOAD	-300.0 to 300.0 (2)	REAL	h9
622	65.02	AT OR ABOVE LOAD		AT LOAD	Output	BOOL	ha
626	70.03	CUSTOM MENU 3	PAR 903	CUSTOM MENU	0 to 1655	TAG	he
627	70.04	CUSTOM MENU 4	PAR 904	CUSTOM MENU	0 to 1655	TAG	hf
628	70.05	CUSTOM MENU 5	PAR 905	CUSTOM MENU	0 to 1655	TAG	hg
629	70.06	CUSTOM MENU 6	PAR 906	CUSTOM MENU	0 to 1655	TAG	hh
630	70.07	CUSTOM MENU 7	PAR 907	CUSTOM MENU	0 to 1655	TAG	hi
631	70.08	CUSTOM MENU 8	PAR 908	CUSTOM MENU	0 to 1655	TAG	hj
641	47.01	INPUT 0		MULTIPLEXER	0 to 1	BOOL	ht
642	47.02	INPUT 1		MULTIPLEXER	0 to 1	BOOL	hu
643	47.03	INPUT 2		MULTIPLEXER	0 to 1	BOOL	hv
644	47.04	INPUT 3		MULTIPLEXER	0 to 1	BOOL	hw
645	47.05	INPUT 4		MULTIPLEXER	0 to 1	BOOL	hx
646	47.06	INPUT 5		MULTIPLEXER	0 to 1	BOOL	hy
647	47.07	INPUT 6		MULTIPLEXER	0 to 1	BOOL	hz
648	47.08	INPUT 7		MULTIPLEXER	0 to 1	BOOL	i0
649	47.09	INPUT 8		MULTIPLEXER	0 to 1	BOOL	i1
650	47.10	INPUT 9		MULTIPLEXER	0 to 1	BOOL	i2
651	47.11	INPUT 10		MULTIPLEXER	0 to 1	BOOL	i3
652	47.12	INPUT 11		MULTIPLEXER	0 to 1	BOOL	i4
653	47.13	INPUT 12		MULTIPLEXER	0 to 1	BOOL	i5
654	47.14	INPUT 13		MULTIPLEXER	0 to 1	BOOL	i6
655	47.15	INPUT 14		MULTIPLEXER	0 to 1	BOOL	i7
656	47.16	INPUT 15		MULTIPLEXER	0 to 1	BOOL	i8
657	48.02	OUTPUT 0		DEMUTIPLEXER	Output	BOOL	i9
658	48.03	OUTPUT 1		DEMUTIPLEXER	Output	BOOL	ia
659	48.04	OUTPUT 2		DEMUTIPLEXER	Output	BOOL	ib
660	48.05	OUTPUT 3		DEMUTIPLEXER	Output	BOOL	ic
661	48.06	OUTPUT 4		DEMUTIPLEXER	Output	BOOL	id
662	48.07	OUTPUT 5		DEMUTIPLEXER	Output	BOOL	ie
663	48.08	OUTPUT 6		DEMUTIPLEXER	Output	BOOL	if
664	48.09	OUTPUT 7		DEMUTIPLEXER	Output	BOOL	ig
665	48.10	OUTPUT 8		DEMUTIPLEXER	Output	BOOL	ih
666	48.11	OUTPUT 9		DEMUTIPLEXER	Output	BOOL	ii
667	48.12	OUTPUT 10		DEMUTIPLEXER	Output	BOOL	ij
668	48.13	OUTPUT 11		DEMUTIPLEXER	Output	BOOL	ik
669	48.14	OUTPUT 12		DEMUTIPLEXER	Output	BOOL	il
670	48.15	OUTPUT 13		DEMUTIPLEXER	Output	BOOL	im
671	48.16	OUTPUT 14		DEMUTIPLEXER	Output	BOOL	in
672	48.17	OUTPUT 15		DEMUTIPLEXER	Output	BOOL	io
680	55.04	BAND 2	SET\SETP ST14	SKIP FREQUENCIES	0.0 to 60.0	REAL	iw
686	28.02	REGEN LIM ENABLE		CURRENT LIMIT	0 to 1	BOOL	j2
689	63.02	MODE	SET\CTRL CL20	AUTOTUNE	0 : STATIONARY 1 : ROTATING	ENUM	j5
691	42.05	SRAMP CONTINUOUS	SET\SETP ST05	REFERENCE RAMP	0 to 1	BOOL	j7
694	42.04	SRAMP JERK 1	SET\SETP ST04	REFERENCE RAMP	0.01 to 100.00	REAL	ja
698	42.07	RAMPING		REFERENCE RAMP	Output	BOOL	je
709	57.09	REFLUX TIME		FLYCATCHING	0.1 to 20.0	REAL	jp
710	30.01	DEFLUX TIME		INJ BRAKING	0.1 to 20.0	REAL	jq
725	13.6.1	INVERT	SET\IN IP06	DIGITAL INPUT 6 (Terminal 12)	0 to 1	BOOL	k5
726	13.6.2	VALUE	SET\IN IPD6	DIGITAL INPUT 6 (Terminal 12)	Output	BOOL	k6
727	13.7.1	INVERT	SET\IN IP07	DIGITAL INPUT 7 (Terminal 13)	0 to 1	BOOL	k7
728	13.7.2	VALUE	SET\IN IPD7	DIGITAL INPUT 7 (Terminal 13)	Output	BOOL	k8
736	14.3.2	INVERT	SET\OUT OP32	DIGITAL OUTPUT 3 (Relay)	0 to 1	BOOL	kg
737	14.3.1	VALUE	SET\OUT OP33	DIGITAL OUTPUT 3 (Relay)	0 to 1	BOOL	kh

Parameter Specification 2-11

TAG	Pref	CELITE Name	MMI Name	Function Block Name	Range	Type	ID
739	30.08	BASE VOLTS		INJ BRAKING	0.00 to 115.47	REAL	kj
740	50.04	ACTIVE TRIPS+		TRIPS STATUS	Output	WORD	kk
741	50.06	WARNINGS+		TRIPS STATUS	Output	WORD	kl
742	50.02	DISABLE TRIPS+	SET\TRIP OT	TRIPS STATUS	0x0000 to 0xFFFF	WORD	km
744	40.04	TRIGGERS 1+	SET\SETP ST24	AUTO RESTART	0x0000 to 0xFFFF	WORD	ko
747	66.02	RESET	SET\ENC EN02	ENCODER	0 to 1	BOOL	kr
748	66.07	POSITION		ENCODER	Output	REAL	ks
749	27.08	SPEED FBK %		FEEDBACKS	Output	REAL	kt
760	54.01	INVERT THERMIST		IO TRIPS	0 to 1	BOOL	l4
770	23.14	COMMS SETPOINT		REFERENCE	Output (2)	REAL	le
878	21.02	DETAILED MENU	SET\SETP ST99	MMI ACCESS	0 to 1	BOOL	oe
1020	27.05	TERMINAL VOLTS		FEEDBACKS	Output	REAL	sc
1025	63.03	TEST DISABLE		AUTOTUNE	0x0000 to 0xFFFF	WORD	sh
1058	33.07	601 FLUXING	SET\CTRL CL07	FLUXING	0 to 1	BOOL	te
1059	18.07	P3 PORT PROTOCOL	SET\SERL SE08	COMMS PORTS	0 : AUTOMATIC 1 : KEYPAD 2 : EIBISYNC ASCII 3 : MODBUS 4 : FIELDBUS	ENUM	ff
1060	18.06	OP PORT PROTOCOL	SET\SERL SE07	COMMS PORTS	0 : AUTOMATIC 1 : KEYPAD 2 : EIBISYNC ASCII 3 : MODBUS 4 : FIELDBUS	ENUM	tg
1061	18.04	PARITY	SET\SERL SE05	COMMS PORTS	0 : NONE 1 : ODD 2 : EVEN	ENUM	th
1062	18.03	BAUD RATE	SET\SERL SE04	COMMS PORTS	0 : 1200 1 : 2400 2 : 4800 3 : 7200 4 : 9600 5 : 14400 6 : 19200 7 : 38400 8 : 57600	ENUM	ti
1064	7.05	APP LOCK	SET\SETP ST98	APP CONFIG	0 to 1	BOOL	tk
1091	7.01	APPLICATION	PAR 1	APP CONFIG	0 : NULL 1 : STANDARD 2 : LOCAL/REM 3 : PRESETS 4 : RAISE/LOWER 5 : PID 6 : APP 6 7 : APP 7 8 : APP 8 9 : CUSTOM	ENUM	ub
1092	7.02	ANOUT SOURCE	SET\OUT OP01	APP CONFIG	0 : NONE 1 : DEMAND 2 : CURRENT 3 : PID ERROR 4 : R/L OUTPUT	ENUM	uc
1093	7.03	RELAY SOURCE	SET\OUT OP31	APP CONFIG	0 : NONE 1 : HEALTH 2 : TRIPPED 3 : RUNNING 4 : AT ZERO 5 : AT SPEED 6 : AT LOAD	ENUM	ud
1094	7.04	DIGIO 2 SOURCE	SET\OUT OP21	APP CONFIG	0 : NONE 1 : HEALTH 2 : TRIPPED 3 : RUNNING 4 : AT ZERO 5 : AT SPEED 6 : AT LOAD	ENUM	ue
1095	52.01	HYSTERISIS		AT SPEED	0.0 to 300.0 (2)	REAL	uf
1096	52.02	AT SPEED		AT SPEED	Output	BOOL	ug
1098	46.11	INTEGRAL DEFEAT		PID	0 to 1	BOOL	ui
1110	22.03	DISP 2 VERSION		DISPLAY/KEYPAD	Output	WORD	uu
1148	32.01	AIMING POINT		INVERSE TIME	50.0 to 150.0 (2)	REAL	vw
1149	32.02	DELAY		INVERSE TIME	5.0 to 30.0	REAL	vx

2-12 Parameter Specification



TAG	Pref	CELITE Name	MMI Name	Function Block Name	Range	Type	ID
1150	32.03	DOWN TIME		INVERSE TIME	1.0 to 10.0	REAL	vy
1151	32.04	UP TIME		INVERSE TIME	1.0 to 600.0	REAL	vz
1152	32.05	IT LIMITING		INVERSE TIME	Output	BOOL	w0
1153	32.06	INVERSE TIME OP		INVERSE TIME	Output (2)	REAL	w1
1155	54.03	THERMIST STATE		IO TRIPS	Output	BOOL	w3
1157	35.07	CONTROL MODE	SET\CTRL CL01	MOTOR DATA	0 : VOLTS / Hz 1 : SENSORLESS VEC	ENUM	w5
1158	35.08	POWER	SET\CTRL CL15	MOTOR DATA	0.00 to 355.00 (1)	REAL	w6
1159	35.01	BASE FREQUENCY	PAR 7	MOTOR DATA	7.5 to 240.0	REAL	w7
1160	35.02	MOTOR VOLTAGE	SET\CTRL CL12	MOTOR DATA	0.0 to 575.0	REAL	w8
1163	35.17	ROTOR TIME CONST	SET\CTRL CL1A	MOTOR DATA	10.00 to 3000.00 (1)	REAL	wb
1164	35.11	OVERLOAD		MOTOR DATA	1.0 to 5.0	REAL	wc
1187	59.01	SPEED PROP GAIN	SET\CTRL CL91	SPEED LOOP	0.00 to 300.00	REAL	wz
1188	59.02	SPEED INT TIME	SET\CTRL CL92	SPEED LOOP	1. to 15000.	REAL	x0
1189	59.03	INT DEFEAT		SPEED LOOP	0 to 1	BOOL	x1
1190	59.04	SPEED INT PRESET		SPEED LOOP	-500.00 to 500.00 (1)	REAL	x2
1191	59.05	SPEED DMD FILTER		SPEED LOOP	0.0 to 14.0	REAL	x3
1192	59.06	SPEED FBK FILTER		SPEED LOOP	0.0 to 15.0	REAL	x4
1193	59.07	(AUX) TORQUE DMD		SPEED LOOP	-300.00 to 300.00	REAL	x5
1200	59.08	SPEED POS LIM	SET\CTRL CL93	SPEED LOOP	-110.00 to 110.00	REAL	xc
1201	59.09	SPEED NEG LIM	SET\CTRL CL94	SPEED LOOP	-110.00 to 110.00	REAL	xd
1202	59.10	TORQ CTRL MODE		SPEED LOOP	0 to 1	BOOL	xe
1203	59.11	TOTL SPD DMD RPM		SPEED LOOP	Output (0)	REAL	xf
1204	59.14	TORQUE DEMAND		SPEED LOOP	Output	REAL	xg
1206	59.12	TOTAL SPD DMD %		SPEED LOOP	Output	REAL	xi
1207	59.13	SPEED ERROR		SPEED LOOP	Output	REAL	xj
1208	38.01	POS TORQUE LIM	SET\CTRL CL82	TORQUE LIMIT	-500.0 to 500.0	REAL	xk
1209	38.02	NEG TORQUE LIM	SET\CTRL CL83	TORQUE LIMIT	-500.0 to 500.0	REAL	xl
1210	38.03	MAIN TORQUE LIM		TORQUE LIMIT	0.0 to 500.0	REAL	xm
1211	38.04	SYMMETRIC LIM		TORQUE LIMIT	0 to 1	BOOL	xn
1212	38.05	ACTUAL POS LIM		TORQUE LIMIT	Output (2)	REAL	xo
1213	38.06	ACTUAL NEG LIM		TORQUE LIMIT	Output (2)	REAL	xp
1233	49.03	AT ZERO SPEED		ZERO SPEED	Output	BOOL	y9
1235	24.05	CONTACTOR CLOSED		SEQUENCING LOGIC	0 to 1	BOOL	yb
1247	46.01	SETPOINT		PID	-300.00 to 300.00	REAL	yn
1248	46.03	FEED FWD		PID	-300.00 to 300.00	REAL	yo
1249	46.05	FEED FWD GAIN		PID	-10.00 to 10.00	REAL	yp
1250	46.06	P GAIN	PAR 501	PID	0.00 to 100.00	REAL	yq
1251	46.07	I GAIN	PAR 502	PID	0.00 to 100.00	REAL	yr
1252	46.08	D GAIN	PAR 503	PID	0.00 to 100.00	REAL	ys
1253	46.09	LIMIT	PAR 506	PID	0.00 to 300.00	REAL	yt
1254	46.10	ENABLE PID		PID	0 to 1	BOOL	yu
1255	46.12	D FILTER TC	PAR 504	PID	0.05 to 5.00	REAL	yv
1256	46.13	OUTPUT	PAR 509	PID	Output	REAL	yw
1257	46.15	LIMITING		PID	Output	BOOL	yx
1258	46.16	OUTPUT SCALING	PAR 507	PID	-3.0000 to 3.0000	REAL	yy
1259	65.03	ABSOLUTE	SET\SETP ST43	AT LOAD	0 to 1	BOOL	yz
1260	18.05	REPLY DELAY ms	SET\SERL SE06	COMMS PORTS	0 to 200	INT	z0
1553	57.02	VECTOR ENABLE	SET\CTRL CL03	FLYCATCHING	0 to 1	BOOL	ix
1554	38.07	FAST STOP T-LIM		TORQUE LIMIT	-300.00 to 300.00	REAL	iy
1603	64.01	RESET		ENERGY METER	0 to 1	BOOL	iv
1604	64.02	POWER		ENERGY METER	Output (1)	REAL	iw
1605	64.03	POWER		ENERGY METER	Output (1)	REAL	ix
1606	64.04	REACTIVE POWER		ENERGY METER	Output (1)	REAL	iy
1607	64.05	ENERGY USED		ENERGY METER	Output	REAL	iz
1632	56.03	STALL LIMIT TYPE	SET\CTRL CL84	STALL TRIP	0 to 1	BOOL	mY
1655	33.08	ENERGY SAVING	SET\CTRL CL09	FLUXING	0 to 1	BOOL	nV

MMI Parameters

MMI Name	ASCII MMI Name	Function Block Name	CELITE Name	Notes	TAG	ID
PAR Menu (Parameter)						
PAR 1	APPLICATION	APP CONFIG	APPLICATION		1091	ub
PAR 2	MAX SPEED	REFERENCE	MAX SPEED	M	57	1l
PAR 3	MIN SPEED	MINIMUM SPEED	MINIMUM		337	9d
PAR 4	ACCEL TIME	REFERENCE RAMP	ACCEL TIME		258	76
PAR 5	DECEL TIME	REFERENCE RAMP	DECEL TIME		259	77
PAR 6	MOTOR CURRENT	MOTOR DATA	MOTOR CURRENT	M	64	1s
PAR 7	BASE FREQUENCY	MOTOR DATA	BASE FREQUENCY	M	1159	w7
PAR 8	JOG SETPOINT	REFERENCE JOG	SETPOINT		246	6u
PAR 9	RUN STOP MODE	REFERENCE STOP	RUN STOP MODE		279	7r
PAR 11	V/F SHAPE	FLUXING	V/F SHAPE		104	2w
PAR 12	NORMAL DUTY	FEEDBACKS	NORMAL DUTY		50	1e
PAR 13	FIXED BOOST	FLUXING	FIXED BOOST	M VF	107	2z
PAR 99	PASSWORD	MMI ACCESS	PASSWORD		8	08
PAR 301	PRESET 0	PRESET 1	INPUT 0		347	9n
PAR 302	PRESET 1	PRESET 1	INPUT 1		348	9o
PAR 303	PRESET 2	PRESET 1	INPUT 2		349	9p
PAR 304	PRESET 3	PRESET 1	INPUT 3		350	9q
PAR 305	PRESET 4	PRESET 1	INPUT 4		351	9r
PAR 306	PRESET 5	PRESET 1	INPUT 5		352	9s
PAR 307	PRESET 6	PRESET 1	INPUT 6		353	9t
PAR 308	PRESET 7	PRESET 1	INPUT 7		354	9u
PAR 401	RL RAMP RATE	RAISE/LOWER	RAMP TIME		326	92
PAR 402	RL MAX VALUE	RAISE/LOWER	MAX VALUE		330	96
PAR 403	RL MIN VALUE	RAISE/LOWER	MIN VALUE		329	95
PAR 404	RL RESET VALUE	RAISE/LOWER	RESET VALUE		331	97
PAR 501	PI P GAIN	PID	P GAIN		1250	yq
PAR 502	PI I GAIN	PID	I GAIN		1251	yr
PAR 503	PID D GAIN	PID	D GAIN	F	1252	ys
PAR 504	PID D FILTER TC	PID	D FILTER TC	F	1255	yv
PAR 505	PID FBK GAIN	PID	FEEDBACK GAIN	F	618	h6
PAR 506	PID LIMIT	PID	LIMIT	F	1253	yt
PAR 507	PID SCALE	PID	OUTPUT SCALING	F	1258	YY
PAR 508	PID ERROR	PID	ERROR	F	619	h7
PAR 509	PID OUTPUT	PID	OUTPUT	F	1256	yw
PAR 901	CUSTOM MENU 1	CUSTOM MENU	CUSTOM MENU 1		74	22
PAR 902	CUSTOM MENU 2	CUSTOM MENU	CUSTOM MENU 2		371	ab
PAR 903	CUSTOM MENU 3	CUSTOM MENU	CUSTOM MENU 3		626	he
PAR 904	CUSTOM MENU 4	CUSTOM MENU	CUSTOM MENU 4		627	hf
PAR 905	CUSTOM MENU 5	CUSTOM MENU	CUSTOM MENU 5		628	hg
PAR 906	CUSTOM MENU 6	CUSTOM MENU	CUSTOM MENU 6		629	hh
PAR 907	CUSTOM MENU 7	CUSTOM MENU	CUSTOM MENU 7		630	hi
PAR 908	CUSTOM MENU 8	CUSTOM MENU	CUSTOM MENU 8		631	hj
CTRL Menu (Control)						
SET\CTRL CL01	CONTROL MODE	MOTOR DATA	CONTROL MODE		1157	w5
SET\CTRL CL02	NAMEPLATE RPM	MOTOR DATA	NAMEPLATE RPM	M	83	2b
SET\CTRL CL03	FLY-CATCH ENABLE	FLYCATCHING	VHz ENABLE	VF	570	fu
SET\CTRL CL03	FLY-CATCH ENABLE	FLYCATCHING	VECTOR ENABLE	SV	1553	jX
SET\CTRL CL04	SLIP COMP ENABLE	SLIP COMP	ENABLE	VF	82	2a
SET\CTRL CL05	STAB ENABLE	STABILISATION	ENABLE	VF	128	3k
SET\CTRL CL06	VOLTS CTRL MODE	VOLTAGE CONTROL	VOLTAGE MODE	VF	595	gj
SET\CTRL CL07	BOOST MODE	FLUXING	601 FLUXING	F M VF	1058	te
SET\CTRL CL08	AUTO BOOST	FLUXING	AUTO BOOST	F M VF	108	30
SET\CTRL CL09	ENERGY SAVING	FLUXING	ENERGY SAVING	F VF	1655	nV
SET\CTRL CL10	MOTOR CURRENT	MOTOR DATA	MOTOR CURRENT	M SV	64	1s
SET\CTRL CL11	MOTOR POLES	MOTOR DATA	MOTOR POLES	M SV	84	2c

2-14 Parameter Specification

MMI Name	ASCII MMI Name	Function Block Name	CELITE Name	Notes	TAG	ID
SET\CTRL CL12	MOTOR VOLTAGE	MOTOR DATA	MOTOR VOLTAGE	M SV	1160	w8
SET\CTRL CL14	MAG CURRENT	MOTOR DATA	MAG CURRENT	M	65	1t
SET\CTRL CL15	POWER	MOTOR DATA	POWER	M SV	1158	w6
SET\CTRL CL16	MOTOR CONNECTION	MOTOR DATA	MOTOR CONNECTION	M SV	124	3g
SET\CTRL CL17	STATOR RES	MOTOR DATA	STATOR RES	F M SV	119	3b
SET\CTRL CL18	LEAKAGE INDUC	MOTOR DATA	LEAKAGE INDUC	F M SV	120	3c
SET\CTRL CL19	MUTUAL INDUC	MOTOR DATA	MUTUAL INDUC	F M SV	121	3d
SET\CTRL CL1A	ROTOR TIME CONST	MOTOR DATA	ROTOR TIME CONST	F M SV	1163	wb
SET\CTRL CL20	AUTOTUNE MODE	AUTOTUNE	MODE	SV	689	j5
SET\CTRL CL21	AUTOTUNE ENABLE	AUTOTUNE	ENABLE	SV	603	gr
SET\CTRL CL81	CURRENT LIMIT	CURRENT LIMIT	CURRENT LIMIT	F	365	a5
SET\CTRL CL82	POS TORQUE LIMIT	TORQUE LIMIT	POS TORQUE LIM	F	1208	xk
SET\CTRL CL83	NEG TORQUE LIMIT	TORQUE LIMIT	NEG TORQUE LIM	F	1209	xl
SET\CTRL CL84	STALL TRIP TYPE	STALL TRIP	STALL LIMIT TYPE	F	1632	mY
SET\CTRL CL91	SPEED PROP GAIN	SPEED LOOP	SPEED PROP GAIN	F M SV	1187	wz
SET\CTRL CL92	SPEED INT TIME	SPEED LOOP	SPEED INT TIME	F M SV	1188	x0
SET\CTRL CL93	SPEED POS LIMIT	SPEED LOOP	SPEED POS LIM	F SV	1200	xc
SET\CTRL CL94	SPEED NEG LIMIT	SPEED LOOP	SPEED NEG LIM	F SV	1201	xd
IN Menu (Input)						
SET\IN IP01	DIGIN 1 INVERT	DIGITAL INPUT 1 (Terminal 7)	INVERT		30	0u
SET\IN IP02	DIGIN 2 INVERT	DIGITAL INPUT 2 (Terminal 8)	INVERT		33	0x
SET\IN IP03	DIGIN 3 INVERT	DIGITAL INPUT 3 (Terminal 9)	INVERT		36	10
SET\IN IP04	DIGIN 4 INVERT	DIGITAL INPUT 4 (Terminal 10)	INVERT		39	13
SET\IN IP05	DIGIN 5 INVERT	DIGITAL INPUT 5 (Terminal 11)	INVERT		42	16
SET\IN IP06	DIGIN 6 INVERT	DIGITAL INPUT 6 (Terminal 12)	INVERT		725	k5
SET\IN IP07	DIGIN 7 INVERT	DIGITAL INPUT 7 (Terminal 13)	INVERT		727	k7
SET\IN IP11	ANIN 1 SCALE	ANALOG INPUT 1	SCALE		14	0e
SET\IN IP12	ANIN 1 OFFSET	ANALOG INPUT 1	OFFSET		15	0f
SET\IN IP13	ANIN 1 TYPE	ANALOG INPUT 1	TYPE		13	0d
SET\IN IP21	ANIN 2 SCALE	ANALOG INPUT 2	SCALE		23	0n
SET\IN IP22	ANIN 2 OFFSET	ANALOG INPUT 2	OFFSET		24	0o
SET\IN IP23	ANIN 2 TYPE	ANALOG INPUT 2	TYPE		22	0m
SET\IN IPD1	DIGIN 1 VALUE	DIGITAL INPUT 1 (Terminal 7)	VALUE	F	31	0v
SET\IN IPD2	DIGIN 2 VALUE	DIGITAL INPUT 2 (Terminal 8)	VALUE	F	34	0y
SET\IN IPD3	DIGIN 3 VALUE	DIGITAL INPUT 3 (Terminal 9)	VALUE	F	37	11
SET\IN IPD4	DIGIN 4 VALUE	DIGITAL INPUT 4 (Terminal 10)	VALUE	F	40	14
SET\IN IPD5	DIGIN 5 VALUE	DIGITAL INPUT 5 (Terminal 11)	VALUE	F	43	17
SET\IN IPD6	DIGIN 6 VALUE	DIGITAL INPUT 6 (Terminal 12)	VALUE	F	726	k6
SET\IN IPD7	DIGIN 7 VALUE	DIGITAL INPUT 7 (Terminal 13)	VALUE	F	728	k8
SET\IN IPA1	ANIN 1 VALUE	ANALOG INPUT 1	VALUE	F	16	0g
SET\IN IPA2	ANIN 2 VALUE	ANALOG INPUT 2	VALUE	F	25	0p
OUT Menu (Output)						
SET\OUT OP01	ANOUT SOURCE	APP CONFIG	ANOUT SOURCE		1092	uc
SET\OUT OP02	ANOUT SCALE	ANALOG OUTPUT	SCALE		46	1a
SET\OUT OP03	ANOUT OFFSET	ANALOG OUTPUT	OFFSET		47	1b
SET\OUT OP04	ANOUT ABS	ANALOG OUTPUT	ABSOLUTE		48	1c
SET\OUT OP05	ANOUT VALUE	ANALOG OUTPUT	VALUE	F	45	19
SET\OUT OP21	DIGOUT 2 SOURCE	APP CONFIG	DIGIO 2 SOURCE		1094	ue
SET\OUT OP22	DIGOUT 2 INVERT	DIGITAL OUTPUT 2 (Terminal 10)	INVERT		54	1i
SET\OUT OP23	DIGOUT 2 VALUE	DIGITAL OUTPUT 2 (Terminal 10)	VALUE	F	55	1j
SET\OUT OP31	RELAY SOURCE	APP CONFIG	RELAY SOURCE		1093	ud
SET\OUT OP32	RELAY INVERT	DIGITAL OUTPUT 3 (Relay)	INVERT		736	kg
SET\OUT OP33	RELAY VALUE	DIGITAL OUTPUT 3 (Relay)	VALUE	F	737	kh

MMI Name	ASCII MMI Name	Function Block Name	CELITE Name	Notes	TAG	ID
TRIP Menu (Trips)						
SET\TRIP LOOP	4 TO 20ma LOOP	TRIPS STATUS	DISABLE TRIPS		231	6f
SET\TRIP T 3	ANIN 2 OVERLOAD	TRIPS STATUS	DISABLE TRIPS		231	6f
SET\TRIP STILL	MOTOR STALLED	TRIPS STATUS	DISABLE TRIPS		231	6f
SET\TRIP OT	MOTOR OVERTEMP	TRIPS STATUS	DISABLE TRIPS+		742	km
SET\TRIP IT	INVERSE TIME	TRIPS STATUS	DISABLE TRIPS		231	6f
SET\TRIP DB R	BRAKE RESISTOR	TRIPS STATUS	DISABLE TRIPS		231	6f
SET\TRIP DB S	BRAKE SWITCH	TRIPS STATUS	DISABLE TRIPS		231	6f
SET\TRIP SPD	SPEED FEEDBACK	TRIPS STATUS	DISABLE TRIPS		231	6f
SET\TRIP OSPD	OVERSPEED	TRIPS STATUS	DISABLE TRIPS+		742	km
SET\TRIP DISP	DISPLAY / KEYPAD	TRIPS STATUS	DISABLE TRIPS		231	6f
SET\TRIP DCRP	VDC RIPPLE	TRIPS STATUS	DISABLE TRIPS+		742	km
SERL Menu (Serial Communications)						
SET\SERL SE01	REMOTE COMMS SEL	COMMS CONTROL	REMOTE COMMS SEL		300	8c
SET\SERL SE02	COMMS TIMEOUT	COMMS CONTROL	COMMS TIMEOUT		309	8l
SET\SERL SE03	COMMS ADDRESS	COMMS PORTS	COMMS ADDRESS		103	2v
SET\SERL SE04	COMMS BAUD RATE	COMMS PORTS	BAUD RATE		1062	ti
SET\SERL SE05	COMMS PARITY	COMMS PORTS	PARITY		1061	th
SET\SERL SE06	REPLY DELAY ms	COMMS PORTS	REPLY DELAY ms		1260	z0
SET\SERL SE07	PROTOCOL, (OP)	COMMS PORTS	OP PORT PROTOCOL		1060	tg
SET\SERL SE08	PROTOCOL, (P3)	COMMS PORTS	P3 PORT PROTOCOL		1059	tf
SET\SERL SE09	PROTOCOL, (485)	COMMS PORTS	RS485 PROTOCOL		117	39
SET\SERL SE10	SWITCH OP PORT	COMMS PORTS	SWITCH OP PORT		129	3l
SETP Menu (Setup)						
SET\SETP ST01	JOG ACCEL TIME	REFERENCE JOG	ACCEL TIME		261	79
SET\SETP ST02	JOG DECEL TIME	REFERENCE JOG	DECEL TIME		262	7a
SET\SETP ST03	RAMP TYPE	REFERENCE RAMP	RAMP TYPE		244	6s
SET\SETP ST04	S RAMP JERK	REFERENCE RAMP	SRAMP JERK 1		694	ja
SET\SETP ST05	S RAMP CONT	REFERENCE RAMP	SRAMP CONTINUOUS		691	j7
SET\SETP ST11	SKIP FREQ 1	SKIP FREQUENCIES	FREQUENCY 1		342	9i
SET\SETP ST12	SKIP FREQ 1 BAND	SKIP FREQUENCIES	BAND 1		341	9h
SET\SETP ST13	SKIP FREQ 2	SKIP FREQUENCIES	FREQUENCY 2		343	9j
SET\SETP ST14	SKIP FREQ 2 BAND	SKIP FREQUENCIES	BAND 2		680	iw
SET\SETP ST21	AR ATTEMPTS	AUTO RESTART	ATTEMPTS		612	h0
SET\SETP ST22	AR DELAY	AUTO RESTART	ATTEMPT DELAY 1		613	h1
SET\SETP ST23	AR TRIGGERS	AUTO RESTART	TRIGGERS 1		609	gx
SET\SETP ST24	AR TRIGGERS+	AUTO RESTART	TRIGGERS 1+		744	ko
SET\SETP ST31	DB ENABLE	DYNAMIC BRAKING	ENABLE		80	28
SET\SETP ST32	DB RESISTANCE	DYNAMIC BRAKING	BRAKE RESISTANCE		77	25
SET\SETP ST33	DB POWER	DYNAMIC BRAKING	BRAKE POWER		78	26
SET\SETP ST34	DB OVER-RATING	DYNAMIC BRAKING	1SEC OVER RATING		79	27
SET\SETP ST41	TORQUE FEEDBACK	FEEDBACKS	TORQUE FEEDBACK		70	1y
SET\SETP ST42	TORQUE LEVEL	AT LOAD	LEVEL		621	h9
SET\SETP ST43	USE ABS TORQUE	AT LOAD	ABSOLUTE		1259	yz
SET\SETP ST51	LOCAL MIN SPEED	REFERENCE	LOCAL MIN SPEED		251	6z
SET\SETP ST52	DISABLED KEYS	DISPLAY/KEYPAD	DISABLED KEYS		127	3j
SET\SETP ST98	APPLICATION LOCK	APP CONFIG	APP LOCK		1064	tk
SET\SETP ST99	DETAILED MENUS	MMI ACCESS	DETAILED MENUS		878	oe
ENC Menu (Encoder)						
SET\ENC EN01	ENC MODE	ENCODER	MODE		565	fp
SET\ENC EN02	ENC RESET	ENCODER	RESET		747	kr
SET\ENC EN03	ENC INVERT	ENCODER	INVERT		567	fr
SET\ENC EN04	ENC LINES	ENCODER	LINES		566	fq
SET\ENC EN05	ENC SPEED SCALE	ENCODER	SPEED SCALE		110	32
SET\ENC EN06	ENC SPEED	ENCODER	SPEED		111	33

2-16 Parameter Specification

Pref Cross Reference Table

Pref is a unique identifier used internally by the MMI, for use by Parker SSD Drives' engineers.
When communicating over Comms, always use the Tag Number.

Pref	TAG	Pref	TAG	Pref	TAG	Pref	TAG	Pref	TAG	Pref	TAG	Pref	TAG	Pref	TAG
7.01	1091	15.7.1	160	16.9.3	222	20.03	262	30.08	739	42.07	698	48.14	669	63.03	1025
7.02	1092	15.4.5	148	17.1.1	355	21.01	8	30.09	583	43.01	279	48.15	670	63.09	604
7.03	1093	15.5.4	154	17.1.10	356	21.02	878	31.01	128	43.02	263	48.16	671	64.01	1603
7.04	1094	15.6.3	157	17.1.11	372	22.01	127	32.01	1148	43.03	266	48.17	672	64.02	1604
7.05	1064	15.7.2	161	16.8.5	218	22.02	230	32.02	1149	43.04	284	49.01	359	64.03	1605
10.01	14	15.8.1	165	16.9.4	224	22.03	1110	32.03	1150	43.05	304	49.02	357	64.04	1606
10.02	15	15.5.5	153	17.1.2	347	23.01	245	32.04	1151	43.06	275	49.03	1233	64.05	1607
10.03	13	15.6.4	159	17.2.1	388	23.02	248	32.05	1152	43.07	264	50.01	231	65.01	621
10.05	16	15.7.3	162	17.2.10	389	23.03	57	32.06	1153	43.08	126	50.02	742	65.02	622
11.01	23	15.8.2	166	17.2.11	373	23.04	252	33.01	104	44.01	327	50.03	4	65.03	1259
11.02	24	15.9.1	170	16.9.5	223	23.05	253	33.02	107	44.02	328	50.04	740	66.01	565
11.03	22	15.6.5	158	17.1.3	348	23.06	243	33.03	108	44.03	326	50.05	5	66.02	747
11.04	26	15.7.4	164	17.2.2	380	23.07	249	33.07	1058	44.04	330	50.06	741	66.03	567
11.06	25	15.8.3	167	17.3.1	398	23.09	255	33.08	1655	44.05	329	50.07	6	66.04	566
12.01	45	15.9.2	171	17.3.10	399	23.10	254	34.01	60	44.06	331	51.01	500	66.05	110
12.02	46	15.7.5	163	17.3.11	374	23.12	256	34.02	62	44.07	332	51.02	501	66.06	111
12.03	47	15.8.4	169	17.1.4	349	23.13	247	34.03	61	44.08	325	51.03	502	66.07	748
12.04	48	15.9.3	172	17.2.3	381	23.14	770	35.01	1159	45.01	336	51.04	503	69.01	584
13.1.1	30	16.1.1	180	17.3.2	390	23.15	250	35.02	1160	45.02	337	51.05	504	69.02	585
13.1.2	31	16.10.1	225	17.4.1	518	23.16	251	35.03	64	45.03	338	51.06	505	69.03	586
13.2.1	33	15.8.5	168	17.4.10	519	24.01	291	35.04	65	45.04	335	51.07	506	69.04	587
13.2.2	34	15.9.4	174	17.4.11	520	24.02	292	35.05	83	46.01	1247	51.08	507	69.05	588
13.3.1	36	16.1.2	181	17.1.5	350	24.03	293	35.06	84	46.02	617	51.09	508	69.06	589
13.3.2	37	16.2.1	185	17.2.4	382	24.04	280	35.07	1157	46.03	1248	51.10	509	69.07	590
13.4.1	39	16.10.2	226	17.3.3	391	24.05	1235	35.08	1158	46.04	618	52.01	1095	70.01	74
13.4.2	40	15.9.5	173	17.4.2	510	24.06	276	35.09	124	46.05	1249	52.02	1096	70.02	371
13.5.1	42	16.1.3	182	17.1.6	351	24.07	277	35.10	242	46.06	1250	53.01	595	70.03	626
13.5.2	43	16.2.2	186	17.2.5	383	24.08	278	35.11	1164	46.07	1251	53.02	112	70.04	627
13.6.1	725	16.3.1	190	17.3.4	392	24.09	294	35.14	119	46.08	1252	54.01	760	70.05	628
13.6.2	726	16.10.3	227	17.4.3	511	24.10	282	35.15	120	46.09	1253	54.02	234	70.06	629
13.7.1	727	16.1.4	184	17.1.7	352	24.11	290	35.16	121	46.10	1254	54.03	1155	70.07	630
13.7.2	728	16.2.3	187	17.2.6	384	24.12	283	35.17	1163	46.11	1098	55.01	340	70.08	631
14.1.1	52	16.3.2	191	17.3.5	393	24.13	289	36.01	80	46.12	1255	55.02	341		
14.1.2	51	16.4.1	195	17.4.4	512	24.14	285	36.03	81	46.13	1256	55.03	342		
14.2.1	55	16.10.4	229	17.1.8	353	24.15	302	36.04	77	46.14	619	55.04	680		
14.2.2	54	16.1.5	183	17.2.7	385	24.16	303	36.05	78	46.15	1257	55.05	343		
14.3.1	737	16.2.4	189	17.3.6	394	24.17	286	36.06	79	46.16	1258	55.06	346		
14.3.2	736	16.3.3	192	17.4.5	513	24.18	288	38.01	1208	47.01	641	56.01	241		
15.1.1	130	16.4.2	196	17.1.9	354	24.19	306	38.02	1209	47.02	642	56.02	240		
15.10.1	175	16.5.1	200	17.2.8	386	24.20	287	38.03	1210	47.03	643	56.03	1632		
15.1.2	131	16.10.5	228	17.3.7	395	24.21	305	38.04	1211	47.04	644	57.01	570		
15.2.1	135	16.2.5	188	17.4.6	514	24.22	301	38.05	1212	47.05	645	57.02	1553		
15.10.2	176	16.3.4	194	18.01	102	24.23	296	38.06	1213	47.06	646	57.03	571		
15.1.3	132	16.4.3	197	18.02	103	24.24	274	38.07	1554	47.07	647	57.04	572		
15.2.2	136	16.5.2	201	18.03	1062	24.25	620	39.01	82	47.08	648	57.05	573		
15.3.1	140	16.6.1	205	18.04	1061	25.01	98	39.02	85	47.09	649	57.06	32		
15.10.3	177	16.3.5	193	18.05	1260	25.02	100	39.03	86	47.10	650	57.07	574		
15.1.4	134	16.4.4	199	18.06	1060	25.03	591	40.01	612	47.11	651	57.08	575		
15.2.3	137	16.5.3	202	18.07	1059	27.01	50	40.02	613	47.12	652	57.09	709		
15.3.2	141	16.6.2	206	18.08	117	27.02	75	40.03	609	47.13	653	57.14	576		
15.4.1	145	16.7.1	210	18.09	129	27.03	66	40.04	744	47.14	654	57.15	28		
15.10.4	179	16.4.5	198	17.2.9	387	27.04	67	40.05	608	47.15	655	59.01	1187		
15.1.5	133	16.5.4	204	17.3.8	396	27.05	1020	40.06	616	47.16	656	59.02	1188		
15.2.4	139	16.6.3	207	17.4.7	515	27.06	569	40.07	614	47.17	598	59.03	1189		
15.3.3	142	16.7.2	211	17.3.9	397	27.07	568	40.08	615	48.01	599	59.04	1190		
15.4.2	146	16.8.1	215	17.4.8	516	27.08	749	41.01	298	48.02	657	59.05	1191		
15.5.1	150	16.5.5	203	17.4.9	517	27.11	70	41.02	265	48.03	658	59.06	1192		
15.10.5	178	16.6.4	209	19.01	300	27.12	73	41.03	299	48.04	659	59.07	1193		
15.2.5	138	16.7.3	212	19.02	307	28.01	365	41.04	281	48.05	660	59.08	1200		
15.3.4	144	16.8.2	216	19.03	308	28.02	686	41.05	297	48.06	661	59.09	1201		
15.4.3	147	16.9.1	220	19.04	309	30.01	710	41.06	257	48.07	662	59.10	1202		
15.5.2	151	16.6.5	208	19.06	295	30.02	577	42.01	244	48.08	663	59.11	1203		
15.6.1	155	16.7.4	214	19.07	270	30.03	578	42.02	258	48.09	664	59.12	1206		
15.3.5	143	16.8.3	217	19.08	272	30.04	579	42.03	259	48.10	665	59.13	1207		
15.4.4	149	16.9.2	221	19.09	273	30.05	580	42.04	694	48.11	666	59.14	1204		
15.5.3	152	16.7.5	213	20.01	246	30.06	581	42.05	691	48.12	667	63.01	603		
15.6.2	156	16.8.4	219	20.02	261	30.07	582	42.06	260	48.13	668	63.02	689		

Product-Related Default Values

All examples given in this book are based on a UK, 400V, 50Hz, 11kW drive.

* Frequency Dependent Defaults

These parameter values (marked with “*” in function block descriptions and Application diagrams) are dependent upon the drive’s “default frequency”.

Changing the “default frequency” parameter from 50Hz to 60Hz, and vice versa, causes the values of the parameters in the table below to be changed.

To change the “default frequency”, power-down the drive. Power-up the drive holding down the STOP and DOWN keys on the keypad. Release the keys to display the ° 0.01 parameter.

Caution

You are now in a menu containing some sensitive and important parameters.

Press the UP key to display the ° 0.02 parameter. Press the M key. The values for this parameter are: 0 = 50Hz default, 1 = 60Hz default. Select the setting using the UP/DOWN keys and then press the E key. Power-down the drive and power-up again holding down the UP and DOWN keys. This resets **ALL** parameters to their correct default values, including Motor Parameters.

Frequency Dependent Defaults					
Display	Parameter	Function Block	Tag	50Hz Operation	60Hz Operation
P 7	BASE FREQUENCY	MOTOR DATA	1159	50Hz	60Hz
5CL02	NAMEPLATE RPM	MOTOR DATA	83	#	1750 RPM
5CL12	MOTOR VOLTAGE	MOTOR DATA	1160	*	*
P 2	MAX SPEED	REFERENCE	57	50Hz	60Hz
5CL16	MOTOR CONNECTION	MOTOR DATA	124	STAR	STAR

The correct value is selected for the size of drive - refer to the Power Dependent Parameters table below
 * The correct value is selected for the drive, however, when 60Hz is selected the 400V unit = 460V

2-18 Parameter Specification

** Power Dependent Defaults

These parameters (marked with “***” in function block descriptions and Application diagrams) are set to a value depending on the drive's overall “power-build” indicated by the Product Code. We recommend that you do not change the Product Code.

230V Build Power Dependent Defaults								
Parameter	Function Block	Tag	Frame 1				Frame 2	
			0.25kW	0.37kW	0.55kW	0.75kW	1.1kW	1.5kW
POWER	MOTOR DATA	1158	0.25 kw	0.37 kw	0.55 kw	0.75 kw	1.10 kw	1.50 kw
MOTOR CURRENT	MOTOR DATA	64	1.50 A	2.20 A	3.00 A	4.00 A	5.50 A	7.00 A
MAG CURRENT	MOTOR DATA	65	0.80 A	0.80 A	1.04 A	1.36 A	2.50 A	3.41 A
NAMEPLATE RPM	MOTOR DATA	83	1380.0 RPM	1380.0 RPM	1400.0 RPM	1400.0 RPM	1420.0 RPM	1420.0 RPM
MOTOR VOLTAGE	MOTOR DATA	1160	230.0 V	230.0 V	230.0 V	230.0 V	230.0 V	230.0 V
POWER FACTOR	MOTOR DATA	242	0.70	0.70	0.70	0.70	0.71	0.78
STATOR RES	MOTOR DATA	119	5.2060 ohms	5.2060 ohms	3.8177 ohms	2.9367 ohms	1.5907 ohms	1.1687 ohms
LEAKAGE INDUC	MOTOR DATA	120	110.47 mH	110.47 mH	81.01 mH	62.32 mH	33.76 mH	24.80 mH
MUTUAL INDUC	MOTOR DATA	121	441.90 mH	441.90 mH	324.06 mH	249.28 mH	135.02 mH	99.20 mH
ROTOR TIME CONST	MOTOR DATA	1163	91.17 ms	91.17 ms	109.40 ms	109.40 ms	136.75 ms	136.75 ms
BRAKE POWER	DYNAMIC BRAKING	78	0.1 kW	0.1 kW	0.1 kW	0.1 kW	0.1 kW	0.1 kW
FREQUENCY	INJ BRAKING	577	9.0 Hz	9.0 Hz	9.0 Hz	9.0 Hz	9.0 Hz	9.0 Hz
DEFLUX TIME	INJ BRAKING	710	0.1 s	0.1 s	0.1 s	0.1 s	0.1 s	0.1 s
BASE VOLTS	INJ BRAKING	739	100.00 %	100.00 %	100.00 %	100.00 %	100.00 %	100.00 %
DC LEVEL	INJ BRAKING	581	10.0 %	10.0 %	10.0 %	10.0 %	3.0 %	3.0 %
DC PULSE	INJ BRAKING	579	2.0 s	2.0 s	2.0 s	2.0 s	2.0 s	2.0 s
FINAL DC PULSE	INJ BRAKING	580	1.0 s	1.0 s	1.0 s	1.0 s	1.0 s	1.0 s
FIXED BOOST	FLUXING	107	5.00%	5.00%	5.00%	5.00%	5.00%	5.00%
ACCEL TIME	REFERENCE RAMP	258	10.0 s	10.0 s	10.0 s	10.0 s	10.0 s	10.0 s
DECEL TIME	REFERENCE RAMP	259	10.0 s	10.0 s	10.0 s	10.0 s	10.0 s	10.0 s
DEFLUX DELAY	PATTERN GEN	100	0.5 s	0.5 s	0.5 s	0.5 s	1.0 s	1.0 s
SEARCH VOLTS	FLYCATCHING	573	9.00 %	9.00 %	9.00 %	9.00 %	9.00 %	9.00 %
SEARCH BOOST	FLYCATCHING	32	40.00 %	40.00 %	40.00 %	40.00 %	40.00 %	40.00 %
SEARCH TIME	FLYCATCHING	574	5.0 s	5.0 s	5.0 s	5.0 s	5.0 s	5.0 s
REFLUX TIME	FLYCATCHING	709	3.0 s	3.0 s	3.0 s	3.0 s	3.0 s	3.0 s
OVERLOAD	MOTOR DATA	1164	2.0	2.0	2.0	2.0	2.0	2.0
SPEED PROP GAIN	SPEED LOOP	1187	20	20	20	20	20	20
SPEED INT TIME	SPEED LOOP	1188	500. ms	500. ms	500. ms	500. ms	500. ms	500. ms
MOTOR CONNECTION	MOTOR DATA	124	1 : STAR	1 : STAR	1 : STAR	1 : STAR	1 : STAR	1 : STAR
BRAKE RESISTANCE	DYNAMIC BRAKING	77	500	500	500	500	500	500
BOOST MODE	FLUXING	1058	1	1	1	1	1	1

230V Build Power Dependent Defaults					
Parameter	Function Block	Tag	Frame 3		
			2.2kW	3.0kW	4.0kW
POWER	MOTOR DATA	1158	2.2 kw	3.0 kw	4.0 kw
MOTOR CURRENT	MOTOR DATA	64	9.60 A	12.30 A	16.40 A
MAG CURRENT	MOTOR DATA	65	3.36 A	3.39 A	4.38 A
NAMEPLATE RPM	MOTOR DATA	83	1420.0 RPM	1445.0 RPM	1450.0 RPM
MOTOR VOLTAGE	MOTOR DATA	1160	230.0 V	230.0 V	230.0 V
POWER FACTOR	MOTOR DATA	242	0.80	0.80	0.83
STATOR RES	MOTOR DATA	119	2.0620 ohms	1.3625 ohms	1.0545 ohms
LEAKAGE INDUC	MOTOR DATA	120	43.76 mH	43.37 mH	33.57 mH
MUTUAL INDUC	MOTOR DATA	121	175.03 mH	173.48 mH	134.27 mH
ROTOR TIME CONST	MOTOR DATA	1163	136.75 ms	276.04 ms	303.65 ms
BRAKE POWER	DYNAMIC BRAKING	78	0.5 kW	0.5 kW	0.5 kW
FREQUENCY	INJ BRAKING	577	9.0 Hz	9.0 Hz	9.0 Hz
DEFLUX TIME	INJ BRAKING	710	0.5 s	0.5 s	0.5 s
BASE VOLTS	INJ BRAKING	739	100.00 %	100.00 %	100.00 %
DC LEVEL	INJ BRAKING	581	3.0 %	3.0 %	3.0 %
DC PULSE	INJ BRAKING	579	2.0 s	2.0 s	2.0 s
FINAL DC PULSE	INJ BRAKING	580	1.0 s	1.0 s	1.0 s
FIXED BOOST	FLUXING	107	3.00%	3.00%	3.00%
ACCEL TIME	REFERENCE RAMP	258	10.0 s	10.0 s	10.0 s
DECEL TIME	REFERENCE RAMP	259	10.0 s	10.0 s	10.0 s
DEFLUX DELAY	PATTERN GEN	100	2.0 s	2.0 s	2.0 s
SEARCH VOLTS	FLYCATCHING	573	9.00 %	9.00 %	9.00 %
SEARCH BOOST	FLYCATCHING	32	40.00 %	40.00 %	40.00 %
SEARCH TIME	FLYCATCHING	574	5.0 s	5.0 s	5.0 s
REFLUX TIME	FLYCATCHING	709	3.0 s	3.0 s	3.0 s
OVERLOAD	MOTOR DATA	1164	2.0	2.0	2.0
SPEED PROP GAIN	SPEED LOOP	1187	20.00	20.00	20.00
SPEED INT TIME	SPEED LOOP	1188	500. ms	500. ms	500. ms
MOTOR CONNECTION	MOTOR DATA	124	1 : STAR	1 : STAR	1 : STAR
BRAKE RESISTANCE	DYNAMIC BRAKING	77	56	36	28
BOOST MODE	FLUXING	1058	1	1	1

2-20 Parameter Specification

400V Build Power Dependent Defaults			Frame 2					
Parameter	Function Block	Tag	0.37kW	0.55kW	0.75kW	1.1kW	1.5kW	2.2kW
POWER	MOTOR DATA	1158	0.37 kw	0.55 kw	0.75 kw	1.10 kw	1.50 kw	2.20 kw
MOTOR CURRENT	MOTOR DATA	64	1.50 A	2.00 A	2.50 A	3.50 A	4.50 A	5.50 A
MAG CURRENT	MOTOR DATA	65	0.44 A	0.60 A	0.78 A	1.00 A	1.44 A	1.96 A
NAMEPLATE RPM	MOTOR DATA	83	1380.0 RPM	1400.0 RPM	1400.0 RPM	1420.0 RPM	1420.0 RPM	1420.0 RPM
MOTOR VOLTAGE	MOTOR DATA	1160	400.0 V	400.0 V	400.0 V	400.0 V	400.0 V	400.0 V
POWER FACTOR	MOTOR DATA	242	0.70	0.70	0.70	0.71	0.71	0.78
STATOR RES	MOTOR DATA	119	15.7459 ohms	11.5470 ohms	8.8823 ohms	1.5907 ohms	4.8113 ohms	3.5348 ohms
LEAKAGE INDUC	MOTOR DATA	120	334.14 mH	245.04 mH	188.49 mH	33.76 mH	102.10 mH	75.01 mH
MUTUAL INDUC	MOTOR DATA	121	1336.55 mH	980.14 mH	753.95 mH	135.02 mH	408.39 mH	300.04 mH
ROTOR TIME CONST	MOTOR DATA	1163	91.17 ms	109.40 ms	109.40 ms	136.75 ms	136.75 ms	136.75 ms
BRAKE POWER	DYNAMIC BRAKING	78	0.1 kW	0.1 kW	0.1 kW	0.1 kW	0.1 kW	0.1 kW
FREQUENCY	INJ BRAKING	577	9.0 Hz	9.0 Hz	9.0 Hz	9.0 Hz	9.0 Hz	9.0 Hz
DEFLUX TIME	INJ BRAKING	710	0.1 s	0.1 s	0.1 s	0.1 s	0.1 s	0.1 s
BASE VOLTS	INJ BRAKING	739	100.00 %	100.00 %	100.00 %	100.00 %	100.00 %	100.00 %
DC LEVEL	INJ BRAKING	581	3.0 %	3.0 %	3.0 %	3.0 %	3.0 %	3.0 %
DC PULSE	INJ BRAKING	579	2.0 s	2.0 s	2.0 s	2.0 s	2.0 s	2.0 s
FINAL DC PULSE	INJ BRAKING	580	1.0 s	1.0 s	1.0 s	1.0 s	1.0 s	1.0 s
FIXED BOOST	FLUXING	107	5.00%	5.00%	5.00%	5.00%	5.00%	5.00%
ACCEL TIME	REFERENCE RAMP	258	10.0 s	10.0 s	10.0 s	10.0 s	10.0 s	10.0 s
DECEL TIME	REFERENCE RAMP	259	10.0 s	10.0 s	10.0 s	10.0 s	10.0 s	10.0 s
DEFLUX DELAY	PATTERN GEN	100	1.0 s	1.0 s	1.0 s	1.0 s	1.0 s	1.0 s
SEARCH VOLTS	FLYCATCHING	573	9.00 %	9.00 %	9.00 %	9.00 %	9.00 %	9.00 %
SEARCH BOOST	FLYCATCHING	32	40.00 %	40.00 %	40.00 %	40.00 %	40.00 %	40.00 %
SEARCH TIME	FLYCATCHING	574	5.0 s	5.0 s	5.0 s	5.0 s	5.0 s	5.0 s
REFLUX TIME	FLYCATCHING	709	3.0 s	3.0 s	3.0 s	3.0 s	3.0 s	3.0 s
OVERLOAD	MOTOR DATA	1164	2.0	2.0	2.0	2.0	2.0	2.0
SPEED PROP GAIN	SPEED LOOP	1187	20	20	20	20	20	20
SPEED INT TIME	SPEED LOOP	1188	500. ms	500. ms	500. ms	500. ms	500. ms	500. ms
MOTOR CONNECTION	MOTOR DATA	124	1 : STAR	1 : STAR	1 : STAR	1 : STAR	1 : STAR	1 : STAR
BRAKE RESISTANCE	DYNAMIC BRAKING	77	500	500	500	200	200	200
BOOST MODE	FLUXING	1058	1	1	1	1	1	1

400V Build Power Dependent Defaults			Frame 3			
Parameter	Function Block	Tag				
POWER	MOTOR DATA	1158	3.00 kw	4.00 kw	5.50 kw	7.50 kw
MOTOR CURRENT	MOTOR DATA	64	6.80 A	9.00 A	12.00 A	16.00 A
MAG CURRENT	MOTOR DATA	65	2.36 A	3.36 A	3.39 A	4.38 A
NAMEPLATE RPM	MOTOR DATA	83	1420.0 RPM	1420.0 RPM	1445.0 RPM	1450.0 RPM
MOTOR VOLTAGE	MOTOR DATA	1160	400.0 V	400.0 V	400.0 V	400.0 V
POWER FACTOR	MOTOR DATA	242	0.8	0.8	0.8	0.8
STATOR RES	MOTOR DATA	119	2.0620 ohms	2.0620 ohms	1.3625 ohms	1.0545 ohms
LEAKAGE INDUC	MOTOR DATA	120	43.76 mH	43.76 mH	43.37 mH	33.57 mH
MUTUAL INDUC	MOTOR DATA	121	175.03 mH	175.03 mH	173.48 mH	134.27 mH
ROTOR TIME CONST	MOTOR DATA	1163	136.75 ms	136.75 ms	276.04 ms	303.65 ms
BRAKE POWER	DYNAMIC BRAKING	78	0.2 kW	0.2 kW	0.5 kW	0.5 kW
FREQUENCY	INJ BRAKING	577	9.0 Hz	9.0 Hz	9.0 Hz	9.0 Hz
DEFLUX TIME	INJ BRAKING	710	0.5 s	0.5 s	0.5 s	0.5 s
BASE VOLTS	INJ BRAKING	739	100.00 %	100.00 %	100.00 %	100.00 %
DC LEVEL	INJ BRAKING	581	3.0 %	3.0 %	3.0 %	3.0 %
DC PULSE	INJ BRAKING	579	2.0 s	2.0 s	2.0 s	2.0 s
FINAL DC PULSE	INJ BRAKING	580	1.0 s	1.0 s	1.0 s	1.0 s
FIXED BOOST	FLUXING	107	5.00%	5.00%	5.00%	5.00%
ACCEL TIME	REFERENCE RAMP	258	10.0 s	10.0 s	10.0 s	10.0 s
DECEL TIME	REFERENCE RAMP	259	10.0 s	10.0 s	10.0 s	10.0 s
DEFLUX DELAY	PATTERN GEN	100	2.0 s	2.0 s	2.0 s	2.0 s
SEARCH VOLTS	FLYCATCHING	573	9.00 %	9.00 %	9.00 %	9.00 %
SEARCH BOOST	FLYCATCHING	32	40.00 %	40.00 %	40.00 %	40.00 %
SEARCH TIME	FLYCATCHING	574	5.0 s	5.0 s	5.0 s	5.0 s
REFLUX TIME	FLYCATCHING	709	3.0 s	3.0 s	3.0 s	3.0 s
OVERLOAD	MOTOR DATA	1164	2.0	2.0	2.0	2.0
SPEED PROP GAIN	SPEED LOOP	1187	20	20	20	20
SPEED INT TIME	SPEED LOOP	1188	500. ms	500. ms	500. ms	500. ms
MOTOR CONNECTION	MOTOR DATA	124	1 : STAR	1 : STAR	1 : STAR	1 : STAR
BRAKE RESISTANCE	DYNAMIC BRAKING	77	100	100	56	56
BOOST MODE	FLUXING	1058	1	1	1	1

2-22 Parameter Specification

230V Build Power Dependent Defaults			Frame C		Frame D		
Parameter	Function Block	Tag	5.5kW	7.5kW	11kW	15kW	18.5kW
POWER	MOTOR DATA	1158	5.50 kw	7.50 kw	11.00 kw	15.00 kw	18.50 kw
MOTOR CURRENT	MOTOR DATA	64	19.65 A	25.39 A	34.78 A	46.96 A	57.16 A
MAG CURRENT	MOTOR DATA	65	5.90 A	7.62 A	10.43 A	14.09 A	17.15 A
NAMEPLATE RPM	MOTOR DATA	83	1445.0 RPM	1450.0 RPM	1460.0 RPM	1470.0 RPM	1470.0 RPM
MOTOR VOLTAGE	MOTOR DATA	1160	230.0 V	230.0 V	230.0 V	230.0 V	230.0 V
POWER FACTOR	MOTOR DATA	242	0.80	0.83	0.86	0.87	0.87
STATOR RES	MOTOR DATA	119	0.4505 ohms	0.3487 ohms	0.2545 ohms	0.1885 ohms	0.1543 ohms
LEAKAGE INDUC	MOTOR DATA	120	14.34 mH	11.10 mH	8.10 mH	6.00 mH	4.91 mH
MUTUAL INDUC	MOTOR DATA	121	57.36 mH	44.39 mH	32.41 mH	24.00 mH	19.64 mH
ROTOR TIME CONST	MOTOR DATA	1163	276.04 ms	303.65 ms	379.56 ms	506.08 ms	506.08 ms
BRAKE POWER	DYNAMIC BRAKING	78	0.1kw	0.1 kw	0.1 kw	0.1 kw	0.1 kw
FREQUENCY	INJ BRAKING	577	9.0 Hz	9.0 Hz	9.0 Hz	9.0 Hz	9.0 Hz
DEFLUX TIME	INJ BRAKING	710	0.5 s	0.5 s	1.0 s	1.0 s	1.0 s
BASE VOLTS	INJ BRAKING	739	100.00%	100.00%	100.00%	100.00%	100.00%
DC LEVEL	INJ BRAKING	581	2.50%	2.50%	1.80%	1.80%	1.80%
DC PULSE	INJ BRAKING	579	2.0 s	2.0 s	2.0 s	2.0 s	2.0 s
FINAL DC PULSE	INJ BRAKING	580	1.0 s	1.0 s	3.0 s	3.0 s	3.0 s
FIXED BOOST	FLUXING	107	0.00%	0.00%	0.00%	0.00%	0.00%
ACCEL TIME	REFERENCE RAMP	258	10.0 s	10.0 s	10.0 s	10.0 s	10.0 s
DECEL TIME	REFERENCE RAMP	259	10.0 s	10.0 s	10.0 s	10.0 s	10.0 s
DEFLUX DELAY	PATTERN GEN	100	2.0 s	2.0 s	3.0 s	3.0 s	3.0 s
SEARCH VOLTS	FLYCATCHING	573	9.00%	9.00%	9.00%	9.00%	9.00%
SEARCH BOOST	FLYCATCHING	32	40.00%	40.00%	15.00%	15.00%	15.00%
SEARCH TIME	FLYCATCHING	574	10.0 s	10.0 s	15.0 s	15.0 s	15.0 s
REFLUX TIME	FLYCATCHING	709	3.0 s	3.0 s	4.0 s	4.0 s	4.0 s
OVERLOAD	MOTOR DATA	1164	2.0	2.0	2.0	2.0	2.0
SPEED PROP GAIN	SPEED LOOP	1187	20.00	20.00	20.00	20.00	20.00
SPEED INT TIME	SPEED LOOP	1188	100 ms	100 ms	100 ms	100 ms	100 ms
MOTOR CONNECTION	MOTOR DATA	124	1 : STAR	1 : STAR	1 : STAR	1 : STAR	1 : STAR
BRAKE RESISTANCE	DYNAMIC BRAKING	77	100	100	100	100	100
BOOST MODE	FLUXING	1058	0	0	0	0	0

230V Build Power Dependent Defaults			Frame E		Frame F	
Parameter	Function Block	Tag	22kW	30kW	37kW	45kW
POWER	MOTOR DATA	1158	22.00 kw	30.00 kw	37.00 kw	45.00 kw
MOTOR CURRENT	MOTOR DATA	64	65.82 A	93.53 A	114.32 A	136.83 A
MAG CURRENT	MOTOR DATA	65	19.75 A	28.06 A	34.27 A	41.05 A
NAMEPLATE RPM	MOTOR DATA	83	1470.0 RPM	1470.0 RPM	1470.0 RPM	1470.0 RPM
MOTOR VOLTAGE	MOTOR DATA	1160	230.0 V	230.0 V	230.0 V	230.0 V
POWER FACTOR	MOTOR DATA	242	0.87	0.87	0.87	0.87
STATOR RES	MOTOR DATA	119	0.1340 ohms	0.0943 ohms	0.0771 ohms	0.0644 ohms
LEAKAGE INDUC	MOTOR DATA	120	4.26 mH	3.00 mH	4.45 mH	2.05 mH
MUTUAL INDUC	MOTOR DATA	121	17.06 mH	12.00 mH	9.82 mH	8.20 mH
ROTOR TIME CONST	MOTOR DATA	1163	506.08 ms	506.08 ms	506.08 ms	506.08 ms
BRAKE POWER	DYNAMIC BRAKING	78	0.1 kw	0.1 kw	0.1 kw	0.1 kw
FREQUENCY	INJ BRAKING	577	6.0 Hz	6.0 Hz	6.0 Hz	6.0 Hz
DEFLUX TIME	INJ BRAKING	710	1.0 s	2.0 s	2.0 s	2.0 s
BASE VOLTS	INJ BRAKING	739	75.00 %	75.00 %	75.00 %	75.00 %
DC LEVEL	INJ BRAKING	581	1.3 %	1.3 %	1.3 %	1.3 %
DC PULSE	INJ BRAKING	579	2.0 s	2.0 s	2.0 s	2.0 s
FINAL DC PULSE	INJ BRAKING	580	3.0 s	3.0 s	3.0 s	3.0 s
FIXED BOOST	FLUXING	107	0.00%	0.00%	0.00%	0.00%
ACCEL TIME	REFERENCE RAMP	258	20.0 s	30.0 s	30.0 s	30.0 s
DECEL TIME	REFERENCE RAMP	259	20.0 s	30.0 s	30.0 s	30.0 s
DEFLUX DELAY	PATTERN GEN	100	4.0 s	4.0 s	4.0 s	4.0 s
SEARCH VOLTS	FLYCATCHING	573	8.00%	8.00%	8.00%	8.00%
SEARCH BOOST	FLYCATCHING	32	15.00%	15.00%	15.00%	15.00%
SEARCH TIME	FLYCATCHING	574	15.0 s	15.0 s	15.0 s	15.0 s
REFLUX TIME	FLYCATCHING	709	5.0 s	6.0 s	6.0 s	6.0 s
OVERLOAD	MOTOR DATA	1164	2.0	2.2	2.2	2.2
SPEED PROP GAIN	SPEED LOOP	1187	20.00	20.00	20.00	20.00
SPEED INT TIME	SPEED LOOP	1188	100 ms	100 ms	100 ms	100 ms
MOTOR CONNECTION	MOTOR DATA	124	1 : STAR	1 : STAR	1 : STAR	1 : STAR
BRAKE RESISTANCE	DYNAMIC BRAKING	77	100	100	100	100
BOOST MODE	FLUXING	1058	0	0	0	0

2-24 Parameter Specification

400V Build Power Dependent Defaults									
Parameter	Function Block	Tag	Frame C			Frame D			
			7.5kW	11kW	15kW	15kW	18.5kW	22kW	30kW
POWER	MOTOR DATA	1158	7.50 kw	11.00 kw	15.00 kw	15.00 kw	18.50 kw	22.00 kw	30.00 kw
MOTOR CURRENT	MOTOR DATA	64	14.60A	20.00A	27.00A	27.00A	33.00A	38.00A	54.00A
MAG CURRENT	MOTOR DATA	65	4.38 A	6.00 A	8.10 A	8.10 A	9.90 A	11.40A	16.20A
NAMEPLATE RPM	MOTOR DATA	83	1450.0 RPM	1460.0 RPM	1470.0 RPM	1470.0 RPM	1460.0 RPM	1460.0 RPM	1470.0 RPM
MOTOR VOLTAGE	MOTOR DATA	1160	400.0 V	400.0 V	400.0 V	400.0 V	400.0 V	400.0 V	400.0 V
POWER FACTOR	MOTOR DATA	242	0.83	0.86	0.87	0.87	0.88	0.88	0.86
STATOR RES	MOTOR DATA	119	1.0545 ohms	0.7698 ohms	0.5702 ohms	0.5702 ohms	0.4665 ohms	0.4052 ohms	0.2851 ohms
LEAKAGE INDUC	MOTOR DATA	120	33.57 mH	24.50 mH	18.15 mH	18.15 mH	14.85 mH	12.90 mH	9.08 mH
MUTUAL INDUC	MOTOR DATA	121	134.27 mH	98.01 mH	72.60 mH	72.60 mH	59.40 mH	51.59 mH	36.30 mH
ROTOR TIME CONST	MOTOR DATA	1163	303.65 ms	379.56 ms	506.08 ms	506.08 ms	379.56 ms	379.56 ms	506.08 ms
BRAKE POWER	DYNAMIC BRAKING	78	0.1kw	0.1kw	0.1kw	0.1kw	0.1kw	0.1kw	0.1kw
FREQUENCY	INJ BRAKING	577	9.0 Hz	9.0 Hz	9.0 Hz	9.0 Hz	9.0 Hz	9.0 Hz	9.0 Hz
DEFLUX TIME	INJ BRAKING	710	0.5 s	0.5 s	0.5 s	1.0 s	1.0 s	1.0 s	1.0 s
BASE VOLTS	INJ BRAKING	739	100.00%	100.00%	100.00%	100.00%	100.00%	100.00%	100.00%
DC LEVEL	INJ BRAKING	581	2.50%	2.50%	2.50%	1.80%	1.80%	1.80%	1.80%
DC PULSE	INJ BRAKING	579	2.0 s	2.0 s	2.0 s	2.0 s	2.0 s	2.0 s	2.0 s
FINAL DC PULSE	INJ BRAKING	580	1.0 s	1.0 s	1.0 s	3.0 s	3.0 s	3.0 s	3.0 s
FIXED BOOST	FLUXING	107	0.00%	0.00%	0.00%	0.00%	0.00%	0.00%	0.00%
ACCEL TIME	REFERENCE RAMP	258	10.0 s	10.0 s	10.0 s	10.0 s	10.0 s	10.0 s	10.0 s
DECEL TIME	REFERENCE RAMP	259	10.0 s	10.0 s	10.0 s	10.0 s	10.0 s	10.0 s	10.0 s
DEFLUX DELAY	PATTERN GEN	100	2.0 s	2.0 s	2.0 s	3.0 s	3.0 s	3.0 s	3.0 s
SEARCH VOLTS	FLYCATCHING	573	9.00%	9.00%	9.00%	9.00%	9.00%	9.00%	9.00%
SEARCH BOOST	FLYCATCHING	32	40.00%	40.00%	40.00%	15.00%	15.00%	15.00%	15.00%
SEARCH TIME	FLYCATCHING	574	10.0 s	10.0 s	10.0 s	15.0 s	15.0 s	15.0 s	15.0 s
REFLUX TIME	FLYCATCHING	709	3.0 s	3.0 s	3.0 s	4.0 s	4.0 s	4.0 s	4.0 s
OVERLOAD	MOTOR DATA	1164	2.0	2.0	2.0	2.0	2.0	2.0	2.0
SPEED PROP GAIN	SPEED LOOP	1187	20.00	20.00	20.00	20.00	20.00	20.00	20.00
SPEED INT TIME	SPEED LOOP	1188	100 ms	100 ms	100 ms	100 ms	100 ms	100 ms	100 ms
MOTOR CONNECTION	MOTOR DATA	124	1 : STAR	1 : STAR	1 : STAR	1 : STAR	1 : STAR	1 : STAR	1 : STAR
BRAKE RESISTANCE	DYNAMIC BRAKING	77	100	100	100	100	100	100	100
BOOST MODE	FLUXING	1058	0	0	0	0	0	0	0

400V Build Power Dependent Defaults								
			Frame E			Frame F		
Parameter	Function Block	Tag	30kW	37kW	45kW	55kW	75kW	90kW
POWER	MOTOR DATA	1158	30.00 kw	37.00 kw	45.00 kw	55.00 kw	75.00 kw	90.00 kw
MOTOR CURRENT	MOTOR DATA	64	54.00A	66.00 A	79.00 A	97.00 A	132.00 A	151.00 A
MAG CURRENT	MOTOR DATA	65	16.20A	19.80 A	23.70 A	29.10 A	39.60 A	45.30 A
NAMEPLATE RPM	MOTOR DATA	83	1470.0 RPM	1470.0 RPM	1470.0 RPM	1475.0 RPM	1475.0 RPM	1480.0 RPM
MOTOR VOLTAGE	MOTOR DATA	1160	400.0 V	400.0 V	400.0 V	400.0 V	400.0 V	400.0 V
POWER FACTOR	MOTOR DATA	242	0.86	0.85	0.87	0.86	0.87	0.90
STATOR RES	MOTOR DATA	119	0.2851 ohms	0.2333 ohms	0.1949 ohms	0.1587 ohms	0.1166 ohms	0.1020 ohms
LEAKAGE INDUC	MOTOR DATA	120	9.08 mH	7.43 mH	6.20 mH	5.05 mH	3.71 mH	3.25 mH
MUTUAL INDUC	MOTOR DATA	121	36.30 mH	29.70 mH	24.81 mH	20.21 mH	14.85 mH	12.98 mH
ROTOR TIME CONST	MOTOR DATA	1163	506.08 ms	506.08 ms	506.08 ms	607.30 ms	607.30 ms	759.12 ms
BRAKE POWER	DYNAMIC BRAKING	78	0.1kw	0.1 kw	0.1 kw	0.1 kw	0.1 kw	0.1 kw
FREQUENCY	INJ BRAKING	577	6.0 Hz	6.0 Hz	6.0 Hz	6.0 Hz	6.0 Hz	6.0 Hz
DEFLUX TIME	INJ BRAKING	710	1.0 s	1.0 s	1.0 s	2.0 s	2.0 s	2.0 s
BASE VOLTS	INJ BRAKING	739	75.00%	75.00%	75.00%	75.00%	75.00%	75.00%
DC LEVEL	INJ BRAKING	581	1.30%	1.30%	1.30%	1.30%	1.30%	1.30%
DC PULSE	INJ BRAKING	579	2.0 s	2.0 s	2.0 s	2.0 s	2.0 s	2.0 s
FINAL DC PULSE	INJ BRAKING	580	3.0 s	3.0 s	3.0 s	3.0 s	3.0 s	3.0 s
FIXED BOOST	FLUXING	107	0.00%	0.00%	0.00%	0.00%	0.00%	0.00%
ACCEL TIME	REFERENCE RAMP	258	20.0 s	20.0 s	20.0 s	30.0 s	30.0 s	30.0 s
DECEL TIME	REFERENCE RAMP	259	20.0 s	20.0 s	20.0 s	30.0 s	30.0 s	30.0 s
DEFLUX DELAY	PATTERN GEN	100	4.0 s	4.0 s	4.0 s	4.0 s	4.0 s	4.0 s
SEARCH VOLTS	FLYCATCHING	573	8.00%	8.00%	8.00%	8.00%	8.00%	8.00%
SEARCH BOOST	FLYCATCHING	32	15.00%	15.00%	15.00%	15.00%	15.00%	15.00%
SEARCH TIME	FLYCATCHING	574	15.0 s	15.0 s	15.0 s	15.0 s	15.0 s	15.0 s
REFLUX TIME	FLYCATCHING	709	5.0 s	5.0 s	5.0 s	6.0 s	6.0 s	6.0 s
OVERLOAD	MOTOR DATA	1164	2.0	2.0	2.0	2.2	2.2	2.2
SPEED PROP GAIN	SPEED LOOP	1187	20.00	20.00	20.00	20.00	20.00	20.00
SPEED INT TIME	SPEED LOOP	1188	100 ms	100 ms	100 ms	100 ms	100 ms	100 ms
MOTOR CONNECTION	MOTOR DATA	124	1 : STAR	1 : STAR	1 : STAR	1 : STAR	1 : STAR	1 : STAR
BRAKE RESISTANCE	DYNAMIC BRAKING	77	100	100	100	100	100	100
BOOST MODE	FLUXING	1058	0	0	0	0	0	0

2-26 Parameter Specification

460V Build Power Dependent Defaults (US)							
Parameter	Function Block	Tag	Frame C			Frame D	
			10HP	15HP	20HP	30HP	40HP
POWER	MOTOR DATA	1158	7.50 kw	11.00 kw	15.00 kw	22.00 kw	30.00 kw
MOTOR CURRENT	MOTOR DATA	64	14.00 A	20.00 A	27.00 A	38.00 A	52.00 A
MAG CURRENT	MOTOR DATA	65	4.38 A	6.00 A	8.10 A	11.40 A	16.20 A
NAMEPLATE RPM	MOTOR DATA	83	1750.0 RPM	1750.0 RPM	1750.0 RPM	1750.0 RPM	1750.0 RPM
MOTOR VOLTAGE	MOTOR DATA	1160	460.0 V	460.0 V	460.0 V	460.0 V	460.0 V
POWER FACTOR	MOTOR DATA	242	0.83	0.86	0.87	0.88	0.86
STATOR RES	MOTOR DATA	119	1.0545 ohms	0.7698 ohms	0.5702 ohms	0.4052 ohms	0.2851 ohms
LEAKAGE INDUC	MOTOR DATA	120	33.57 mH	24.50 mH	18.15 mH	12.90 mH	9.08 mH
MUTUAL INDUC	MOTOR DATA	121	134.27 mH	98.01 mH	72.60 mH	51.59 mH	36.30 mH
ROTOR TIME CONST	MOTOR DATA	1163	303.65 ms	379.56 ms	506.08 ms	379.56 ms	506.08 ms
BRAKE POWER	DYNAMIC BRAKING	78	0.1 kw	0.1 kw	0.1 kw	0.1 kw	0.1 kw
FREQUENCY	INJ BRAKING	577	9.0 Hz	9.0 Hz	9.0 Hz	9.0 Hz	9.0 Hz
DEFLUX TIME	INJ BRAKING	710	0.5 s	0.5 s	0.5 s	1.0 s	1.0 s
BASE VOLTS	INJ BRAKING	739	100.00%	100.00%	100.00%	100.00%	100.00%
DC LEVEL	INJ BRAKING	581	2.50%	2.50%	2.50%	1.80%	1.80%
DC PULSE	INJ BRAKING	579	2.0 s	2.0 s	2.0 s	2.0 s	2.0 s
FINAL DC PULSE	INJ BRAKING	580	1.0 s	1.0 s	1.0 s	3.0 s	3.0 s
FIXED BOOST	FLUXING	107	0.00%	0.00%	0.00%	0.00%	0.00%
ACCEL TIME	REFERENCE RAMP	258	10.0 s	10.0 s	10.0 s	10.0 s	10.0 s
DECEL TIME	REFERENCE RAMP	259	10.0 s	10.0 s	10.0 s	10.0 s	10.0 s
DEFLUX DELAY	PATTERN GEN	100	2.0 s	2.0 s	2.0 s	3.0 s	3.0 s
SEARCH VOLTS	FLYCATCHING	573	9.00%	9.00%	9.00%	9.00%	9.00%
SEARCH BOOST	FLYCATCHING	32	40.00%	40.00%	40.00%	15.00%	15.00%
SEARCH TIME	FLYCATCHING	574	10.0 s	10.0 s	10.0 s	15.0 s	15.0 s
REFLUX TIME	FLYCATCHING	709	3.0 s	3.0 s	3.0 s	4.0 s	4.0 s
OVERLOAD	MOTOR DATA	1164	2.0	2.0	2.0	2.0	2.0
SPEED PROP GAIN	SPEED LOOP	1187	20.00	20.00	20.00	20.00	20.00
SPEED INT TIME	SPEED LOOP	1188	100 ms	100 ms	100 ms	100 ms	100 ms
MOTOR CONNECTION	MOTOR DATA	124	1 : STAR	1 : STAR	1 : STAR	1 : STAR	1 : STAR
BRAKE RESISTANCE	DYNAMIC BRAKING	77	100	100	100	100	100
BOOST MODE	FLUXING	1058	0	0	0	0	0

460V Build Power Dependent Defaults (US)			Frame F			
Parameter	Function Block	Tag	75HP	100HP	125HP	150HP
POWER	MOTOR DATA	1158	55.00 kw	75.00 kw	90.00 kw	90.00 kw
MOTOR CURRENT	MOTOR DATA	64	97.00 A	130.00 A	151.00 A	151.00 A
MAG CURRENT	MOTOR DATA	65	29.10 A	39.60 A	45.30 A	45.30 A
NAMEPLATE RPM	MOTOR DATA	83	1750.0 RPM	1750.0 RPM	1750.0 RPM	1750.0 RPM
MOTOR VOLTAGE	MOTOR DATA	1160	460.0 V	460.0 V	460.0 V	460.0 V
POWER FACTOR	MOTOR DATA	242	0.86	0.87	0.9	0.9
STATOR RES	MOTOR DATA	119	0.1587 ohms	0.1166 ohms	0.1020 ohms	0.1020 ohms
LEAKAGE INDUC	MOTOR DATA	120	5.05 mH	3.71 mH	3.25 mH	3.25 mH
MUTUAL INDUC	MOTOR DATA	121	20.21 mH	14.85 mH	12.98 mH	12.98 mH
ROTOR TIME CONST	MOTOR DATA	1163	607.30 ms	607.30 ms	759.12 ms	759.12 ms
BRAKE POWER	DYNAMIC BRAKING	78	0.1 kw	0.1 kw	0.1 kw	0.1 kw
FREQUENCY	INJ BRAKING	577	6.0 Hz	6.0 Hz	6.0 Hz	6.0 Hz
DEFLUX TIME	INJ BRAKING	710	2.0 s	2.0 s	2.0 s	2.0 s
BASE VOLTS	INJ BRAKING	739	75.00%	75.00%	75.00%	75.00%
DC LEVEL	INJ BRAKING	581	1.30%	1.30%	1.30%	1.30%
DC PULSE	INJ BRAKING	579	2.0 s	2.0 s	2.0 s	2.0 s
FINAL DC PULSE	INJ BRAKING	580	3.0 s	3.0 s	3.0 s	3.0 s
FIXED BOOST	FLUXING	107	0.00%	0.00%	0.00%	0.00%
ACCEL TIME	REFERENCE RAMP	258	30.0 s	30.0 s	30.0 s	30.0 s
DECEL TIME	REFERENCE RAMP	259	30.0 s	30.0 s	30.0 s	30.0 s
DEFLUX DELAY	PATTERN GEN	100	4.0 s	4.0 s	4.0 s	4.0 s
SEARCH VOLTS	FLYCATCHING	573	8.00%	8.00%	8.00%	8.00%
SEARCH BOOST	FLYCATCHING	32	15.00%	15.00%	15.00%	15.00%
SEARCH TIME	FLYCATCHING	574	15.0 s	15.0 s	15.0 s	15.0 s
REFLUX TIME	FLYCATCHING	709	6.0 s	6.0 s	6.0 s	6.0 s
OVERLOAD	MOTOR DATA	1164	2.2	2.2	2.2	2.2
SPEED PROP GAIN	SPEED LOOP	1187	20.00	20.00	20.00	20.00
SPEED INT TIME	SPEED LOOP	1188	100 ms	100 ms	100 ms	100 ms
MOTOR CONNECTION	MOTOR DATA	124	1 : STAR	1 : STAR	1 : STAR	1 : STAR
BRAKE RESISTANCE	DYNAMIC BRAKING	77	100	100	100	100
BOOST MODE	FLUXING	1058	0	0	0	0

2-28 Parameter Specification

Chapter 3 SERIAL COMMUNICATIONS

Communications Technology Options

These options provide a serial data port allowing drives to be linked to form a network. Using a PLC/SCADA or other intelligent device, this network can be continuously controlled to provide supervision and monitoring for each drive in the system

Frames 1, 2 & 3 Option

- RS232/RS485 Communication Module which fits to the front of the drive, replacing the keypad

Frames C, D, E & F Option

- RS485 programming port; a 3-way terminal located on the control board

Refer to the Communications Interface Technical Manual for further details.

DSE

This is Parker SSD Drives' Windows-based block programming software. It has a graphical user-interface and drawing tools to allow you to create block programming diagrams quickly and easily. Contact your local Parker SSD Drives sales office.

Connection to the P3 Port

The port is an un-isolated RS232, 19200 Baud, supporting the standard EI bisynch ASCII communications protocol. Contact Parker SSD Drives for further information.

Note: *Frame C, D, E & F: There are two P3 ports - a port located on the control board and the port used by the keypad*

Using any P3 port on the drive, parameters can be monitored and updated by a suitable PC programming tool, i.e. DSE.

P3 Port

A standard P3 lead is used to connect to the drive.

P3 Port Pin	Lead	Signal
1	Black	0V
2	Red	5V
3	Green	TX
4	Yellow	RX

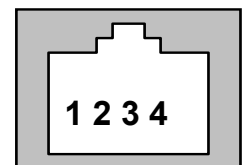

6-Way Lead to DB9/DB25 Connector

Note: *There is 5V present on pin 2 of the P3 port - do not connect this to your PC.*

P3 Port Pin	Lead	Female DB9 Pin	Female DB25 Pin
1	Black	5	7
2	Red	not connected	not connected
3	Green	2	3
4	Yellow	3	2

3-2 Serial Communications

Chapter 4 SEQUENCING LOGIC STATES

Principle State Machine

The drive's reaction to commands is defined by a state machine. This determines which commands provide the demanded action, and in which sequence.

Main Sequencing States

The main sequencing state of the unit is indicated by an enumerated value given by the parameter SEQUENCER STATE under SEQUENCING LOGIC menu at level 3.

Enumerated Value	Main Seq State	Standard Name	Description
0	START DISABLED	Switch On Disabled	The Inverter will not accept a switch on command
1	START ENABLED	Ready To Switch On	The Inverter will accept a switch on command
2	SWITCHED ON	Switched On	The Inverter's stack is enabled
3	READY	Ready	Waiting for Contactor to be closed
4	ENABLED	Enabled	The Inverter is enabled and operational
5	F-STOP ACTIVE	Fast-Stop Active	Fast stop is active
6	TRIP ACTIVE	Trip Active	The Inverter is processing a trip event
7	TRIPPED	Tripped	The Inverter is tripped awaiting trip reset

Table 4-1 Enumerated Values for the SEQUENCING LOGIC Function Block

State Outputs of the SEQUENCING LOGIC Function Block

The following table shows the states of individual parameters for the SEQUENCING LOGIC function block required to produce the condition of the MAIN SEQ STATE parameter.

	START DISABLED	START ENABLED	SWITCHED ON	READY	ENABLED	F-STOP ACTIVE	TRIP ACTIVE	TRIPPED
Tripped	FALSE	FALSE	FALSE	FALSE	FALSE	FALSE	TRUE	TRUE
Running	FALSE	FALSE	FALSE	FALSE	TRUE	FALSE	FALSE	FALSE
Jogging	FALSE	FALSE	FALSE	FALSE	Note 1	FALSE	FALSE	FALSE
Stopping	FALSE	FALSE	FALSE	FALSE	Note 2	TRUE	FALSE	FALSE
Output Contactor	Depends on previous state	Depends on previous state	TRUE	TRUE	TRUE	TRUE	TRUE	FALSE
Switch On Enable	FALSE	TRUE	TRUE	TRUE	TRUE	TRUE	TRUE	FALSE
Switched On	FALSE	FALSE	TRUE	TRUE	TRUE	TRUE	TRUE	FALSE
Ready	FALSE	FALSE	FALSE	TRUE	TRUE	TRUE	TRUE	FALSE
Healthy	TRUE	TRUE	TRUE	TRUE	TRUE	TRUE	FALSE	FALSE Note 3

Table 4-2 Parameter States for the MAIN SEQ STATE Parameter

Note: 1. JOGGING is set TRUE once the jog cycle has started, and remains TRUE until the jog cycle has finished which is when either the stop delay has finished or

4-2 Sequencing Logic

another mode is demanded.

2. *STOPPING is set TRUE during the stopping cycles commanded by either RUNNING going low, JOGGING going low or if Fast Stop is active, i.e. SEQUENCING LOGIC is F-STOP ACTIVE.*
3. *Once Run and Jog are both FALSE, HEALTHY O/P will be set TRUE.*

Transition of States

The transition matrix describes what causes the transition from one state to another, for example see no. 4 below: the transition from “Ready To Switch On” to “Trip Active” is triggered by “TRIP” going TRUE. Note – where a state has more than one exit transition, the transition with the lowest number has priority.

Refer to the following table and state diagram.

	Current State	Next State	Cause (FALSE to TRUE)
1	Power Up	Switch On Disabled	Power-Up, Restore Configuration or exit from Configuration mode.
2	Switch On Disabled	Trip Active	Trip
3	Switch On Disabled	Ready To Switch On	RUN = FALSE, JOG = FALSE, NOT FAST STOP = TRUE and NOT COAST STOP = TRUE
4	Ready To Switch On	Trip Active	Trip
5	Ready To Switch On	Switch On Disabled	NOT COAST STOP = FALSE or NOT FAST STOP = FALSE
6	Ready To Switch On	Switched On	RUN = TRUE or JOG = TRUE
7	Switched On	Trip Active	Trip (includes CONTACTOR CLOSED = FALSE after 10 seconds)
8	Switched On	Switch On Disabled	NOT COAST STOP = FALSE or NOT FAST STOP = FALSE
9	Switched On	Ready To Switch On	RUN = FALSE and JOG = FALSE
10	Switched On	Ready	CONTACTOR CLOSED = TRUE and defluxed
11	Ready	Trip Active	Trip (includes CONTACTOR CLOSED = FALSE)
12	Ready	Switch On Disabled	NOT COAST STOP = FALSE or NOT FAST STOP = FALSE
13	Ready	Ready To Switch On	RUN = FALSE and JOG = FALSE
14	Ready	Enabled	ENABLE = TRUE
15	Enabled	Trip Active	Trip (includes CONTACTOR CLOSED = FALSE)
16	Enabled	Switch On Disabled	NOT COAST STOP = FALSE
17	Enabled	Fast Stop Active	NOT FAST STOP = FALSE
18	Enabled	Ready To Switch On	RUN = FALSE, JOG = FALSE and stopping complete
19	Enabled	Ready	ENABLE = FALSE
20	Fast Stop Active	Trip Active	Trip (includes CONTACTOR CLOSED = FALSE)
21	Fast Stop Active	Switch On Disabled	Fast Stop timer expired or FAST STOP MODE = Coast Stop OR Inverter at zero setpoint
22	Trip Active	Tripped	Stack quenched
23	Tripped	Switch On Disabled	Trip = FALSE and TRIP RESET 0->1 transition

Table 4-3 Transition Matrix

State Diagram

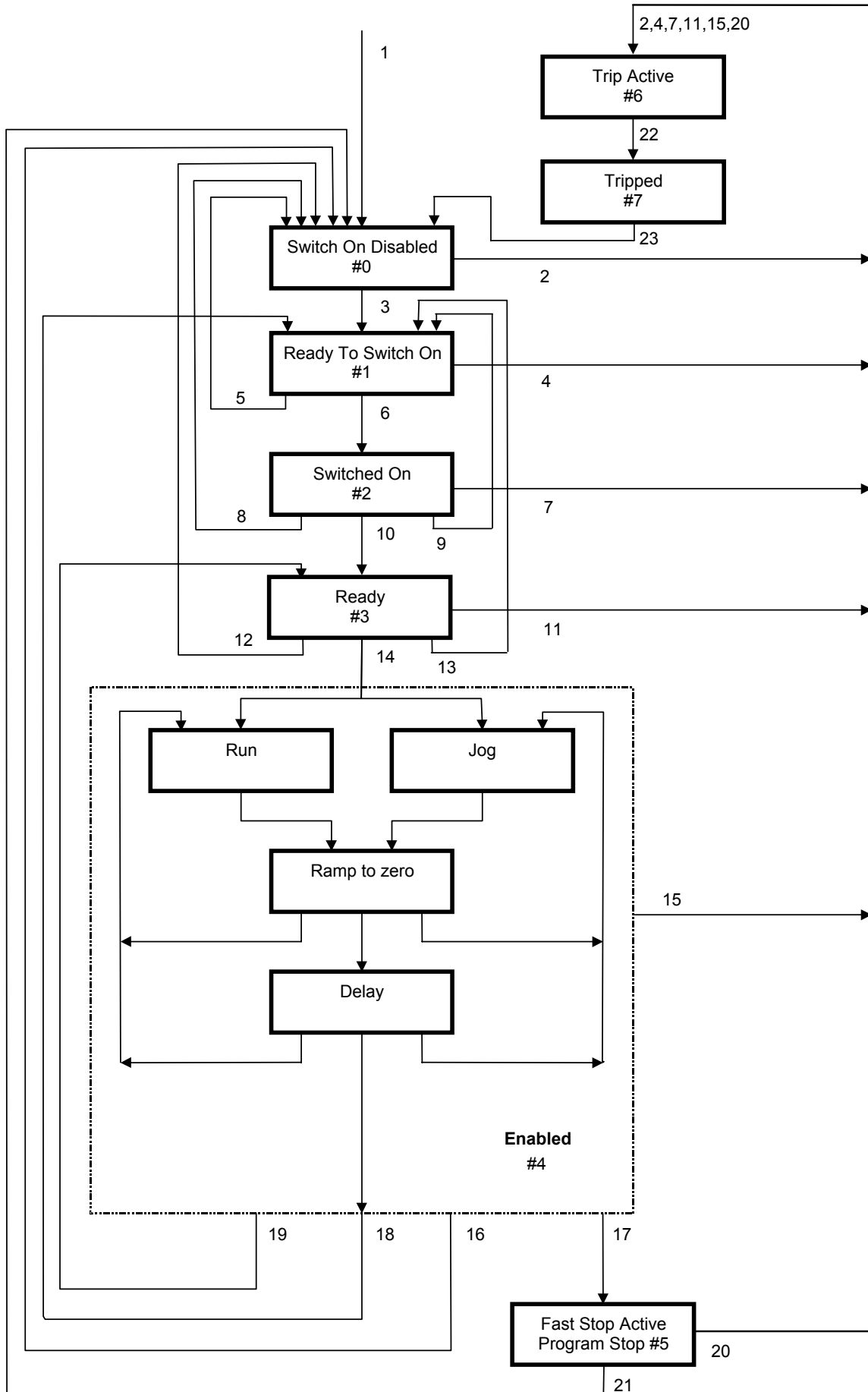

4-4 Sequencing Logic

External Control of the Drive

Communications Command

When sequencing is in the Remote Comms mode, the sequencing of the Inverter is controlled by writing to the hidden parameter COMMS COMMAND (Tag 271). This parameter can only be written to using a communications interface. The output parameter (Tag 273) COMMS COMMAND of the COMMS CONTROL function block is provided as a diagnostic.

The COMMS COMMAND parameter is a 16-bit word based on standard fieldbus drive profiles. Some bits are not implemented in this release (see “Supported” column of the table below).

Bit	Name	Description	Supported	Required Value
0	Switch On	OFF1 Operational	✓	
1	(Not) Disable Voltage	OFF2 Coast Stop	✓	
2	(Not) Quick Stop	OFF3 Fast Stop	✓	
3	Enable Operation		✓	
4	Enable Ramp Output	=0 to set ramp output to zero		1
5	Enable Ramp	=0 to hold ramp		1
6	Enable Ramp Input	=0 to set ramp input to zero		1
7	Reset Fault	Reset on 0 to 1 transition	✓	
8				0
9				0
10	Remote	=1 to control remotely		1
11				0
12				0
13				0
14				0
15				0

Switch On

Replaces the RUN FWD, RUN REV and NOT STOP parameters of the SEQUENCING LOGIC function block. When Set (=1) is the same as :

RUN FWD = TRUE
RUN REV = FALSE
NOT STOP = FALSE

When Cleared (= 0) is the same as :

RUN FWD = FALSE
RUN REV = FALSE
NOT STOP = FALSE

(Not) Disable Voltage

ANDed with the NOT COAST STOP parameter of the SEQUENCING LOGIC function block. When both Set (=1) is the same as:

NOT COAST STOP = TRUE

When either or both Cleared (= 0) is the same as :

NOT COAST STOP = FALSE

(Not) Quick Stop

ANDed with the NOT FAST STOP parameter on the SEQUENCING LOGIC function block.
When both Set (=1) is the same as:

NOT FAST STOP = TRUE

When either or both Cleared (= 0) is the same as :

NOT FAST STOP = FALSE

Enable Operation

ANDed with the DRIVE ENABLE parameter on the SEQUENCING LOGIC function block.
When both Set (=1) is the same as:

DRIVE ENABLE = TRUE

When either or both Cleared (= 0) is the same as :

DRIVE ENABLE = FALSE

Enable Ramp Output, Enable Ramp, Enable Ramp Input

Not implemented. The state of these bits must be set (=1) to allow this feature to be added in the future.

Reset Fault

Replaces the REM TRIP RESET parameter on the SEQUENCING LOGIC function block.
When Set (=1) is the same as:

REM TRIP RESET = TRUE

When Cleared (= 0) is the same as :

REM TRIP RESET = FALSE

Remote

Not implemented. It is intended to allow the PLC to toggle between local and remote. The state of this must be set (=1) to allow this feature to be added in the future.

Example Commands

047F hexadecimal to RUN

047E hexadecimal to STOP

4-6 Sequencing Logic

Communications Status

The COMMS STATUS parameter (Tag 272) in the COMMS CONTROL function block monitors the sequencing of the Inverter. It is a 16-bit word based on standard fieldbus drive profiles. Some bits are not implemented in the initial release and are set to 0 (see “Supported” column of the table below).

Bit	Name	Description	Supported
0	Ready To Switch On		✓
1	Switched On	Ready for operation (refer control bit 0)	✓
2	Operation Enabled	(refer control bit 3)	✓
3	Fault	Tripped	✓
4	(Not) Voltage Disabled	OFF 2 Command pending	✓
5	(Not) Quick Stop	OFF 3 Command pending	✓
6	Switch On Disable	Switch On Inhibited	✓
7	Warning		
8	SP / PV in Range		
9	Remote	= 1 if Drive will accept Command Word	✓
10	Setpoint Reached	The input is True if the system ramp output matches the demanded setpoint.	✓
11	Internal Limit Active	This input is True if the internal current limit is active.	✓
12			
13			
14			
15			

Ready To Switch On

Same as the SWITCH ON ENABLE output parameter of the SEQUENCING LOGIC function block.

Switched On

Same as the SWITCHED ON output parameter of the SEQUENCING LOGIC function block.

Operation Enabled

Same as the RUNNING output parameter of the SEQUENCING LOGIC function block.

Fault

Same as the TRIPPED output parameter of the SEQUENCING LOGIC function block.

(Not) Voltage Disabled

If in Remote Comms mode, this is the same as Bit 1 of the COMMS COMMAND parameter. Otherwise it is the same as the NOT COAST STOP input parameter of the SEQUENCING LOGIC function block.

(Not) Quick Stop

If in Remote Comms mode, this is the same as Bit 2 of the COMMS COMMAND parameter. Otherwise it is the same as the NOT FAST STOP input parameter of the SEQUENCING LOGIC function block.

Switch On Disable

Set (=1) only when in START DISABLED state, refer to Table 4-1.

Remote

This bit is set (= 1) if the Inverter is in Remote mode **AND** the parameter REMOTE COMMS SEL of the COMMS CONTROL function block is Set (= 1).

Chapter 5 APPLICATIONS

The Default Application

The drive is supplied with 6 Applications, Application 0 to Application 5. Each Application recalls a pre-programmed set of parameters and internal links when it is loaded.

DEFAULT

- Application 0 will not control a motor. Loading Application 0 removes all internal links.
- Application 1 is the factory default application, providing for basic speed control
- Application 2 supplies speed control using a manual or auto setpoint
- Application 3 supplies speed control using preset speeds
- Application 4 is a set-up providing speed control with Raise/Lower Trim digital inputs
- Application 5 supplies speed control with PID control

How to Load an Application

The Applications are stored in the **PRΓ** menu.

From the **PRΓ** menu, go to parameter **P 1** by pressing the **M** key twice.

Use the **▲** **▼** keys to select the appropriate Application by number.

Press the **E** key to load the Application.

Application Description

Note: Parameters whose default values are product-related are indicated in the block diagrams with * or **. Refer to Chapter 2: "Parameter Specification" - Product-Related Default Values.

5-2 Applications

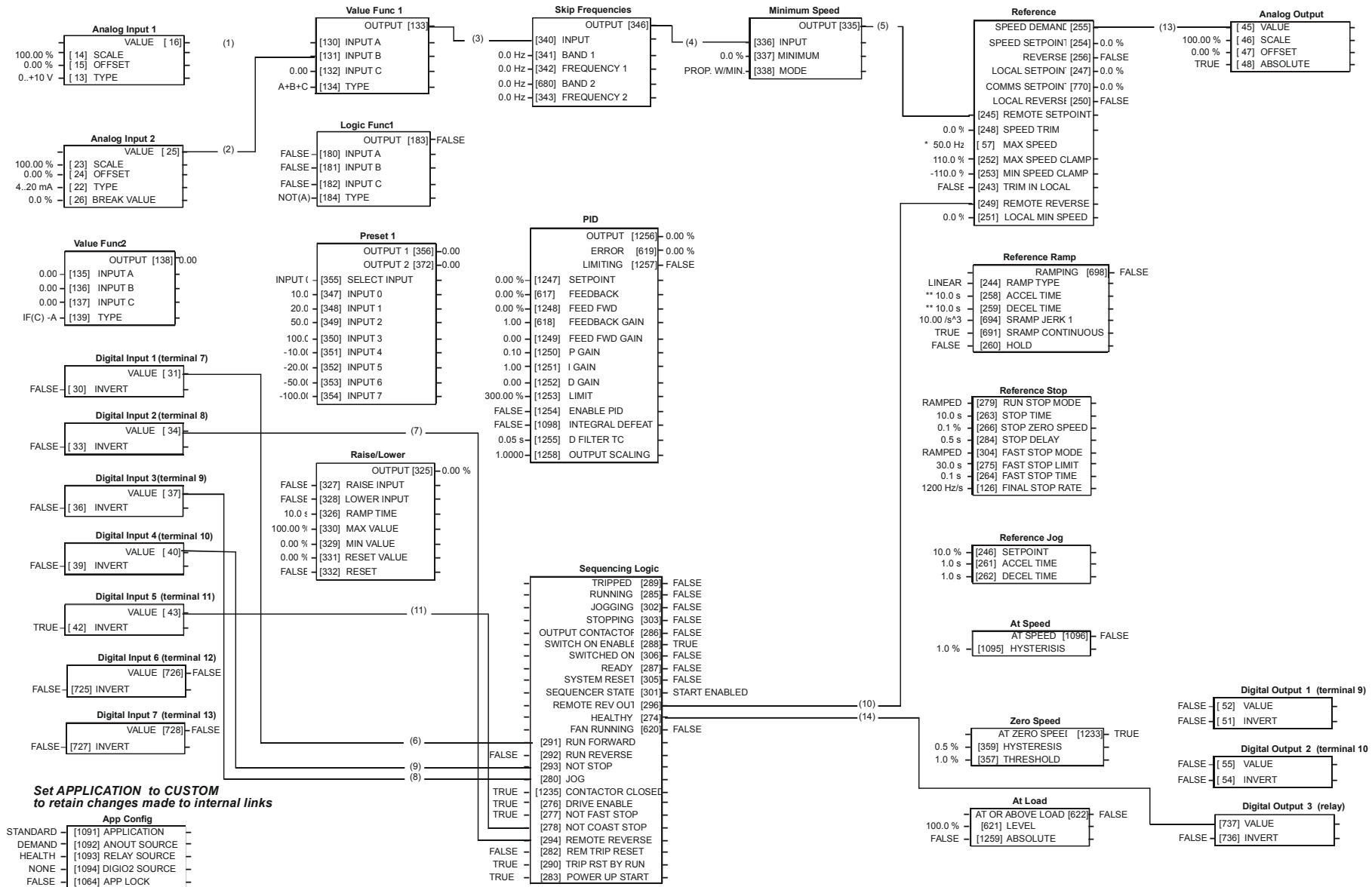

Application 1: Basic Speed Control (default)

Application 1: Basic Speed Control (default)

This Application is ideal for general purpose applications. It provides push-button or switched start/stop control. The setpoint is the sum of the two analogue inputs AIN1 and AIN2, providing Speed Setpoint + Speed Trim capability.

Control Wiring I/O			
Terminal	Name	Purpose	Comment
13	DIGITAL INPUT 7	<i>Not configured</i>	<i>Not Used</i>
11	DIGITAL INPUT 5	Not Coast Stop (inverted)	24V = coast to stop 0V = drive may run
10	DIGITAL INPUT 4	Not Stop	24V = RUN FWD and RUN REV signals latched 0V = RUN FWD and RUN REV signals not latched
9	DIGITAL INPUT 3	Jog	24V = jog
8	DIGITAL INPUT 2	Direction	0V = remote forward 24V = remote reverse
7	DIGITAL INPUT 1	Run Forward	24V = run forward
5	ANALOG OUTPUT 1	Ramp Output	absolute speed demand 0V = 0%, 10V = 100%
3	ANALOG INPUT 2	Speed Trim	4mA = 0%, 20mA = 100%
2	ANALOG INPUT 1	Speed Setpoint	0V = 0%, 10V = 100%
RL1A RL1B	DIGITAL OUTPUT 3 (relay)	HEALTH	Open = tripped, i.e. not healthy

5-4 Applications

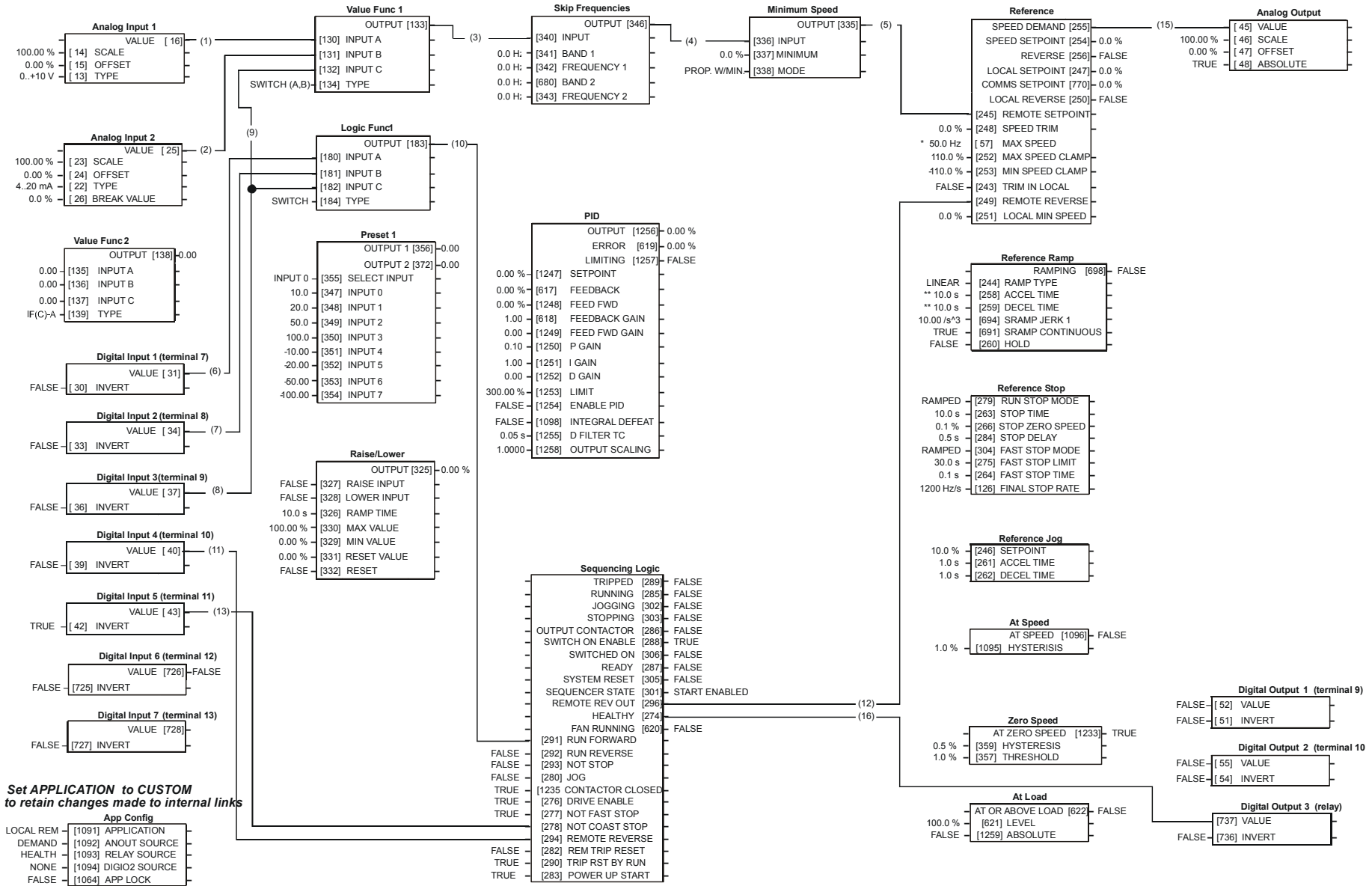

Application 2: Auto/Manual Control

Application 2: Auto/Manual Control

Two Run inputs and two Setpoint inputs are provided. The Auto/Manual switch selects which pair of inputs is active.

The Application is sometimes referred to as Local/Remote.

Control Wiring I/O			
Terminal	Name	Purpose	Comment
12	DIGITAL INPUT 6	<i>Not configured</i>	<i>Not Used</i>
11	DIGITAL INPUT 5	Not Coast Stop (inverted)	24V = coast to stop 0V = drive may run
10	DIGITAL INPUT 4	Remote Reverse	0V = remote forward 24V = remote reverse
9	DIGITAL INPUT 3	Select Auto Run Manual Run	24V = run forward
8	DIGITAL INPUT 2		
7	DIGITAL INPUT 1		
5	ANALOG OUTPUT 1	Ramp Output	absolute speed demand 0V = 0%, 10V = 100%
3	ANALOG INPUT 2	Auto Setpoint	4mA = 0%, 20mA = 100%
2	ANALOG INPUT 1	Manual Setpoint	0V = 0%, 10V = 100%
RL1A RL1B	DIGITAL OUTPUT 3 (relay)	HEALTH	Open = tripped, i.e. not healthy

5-6 Applications

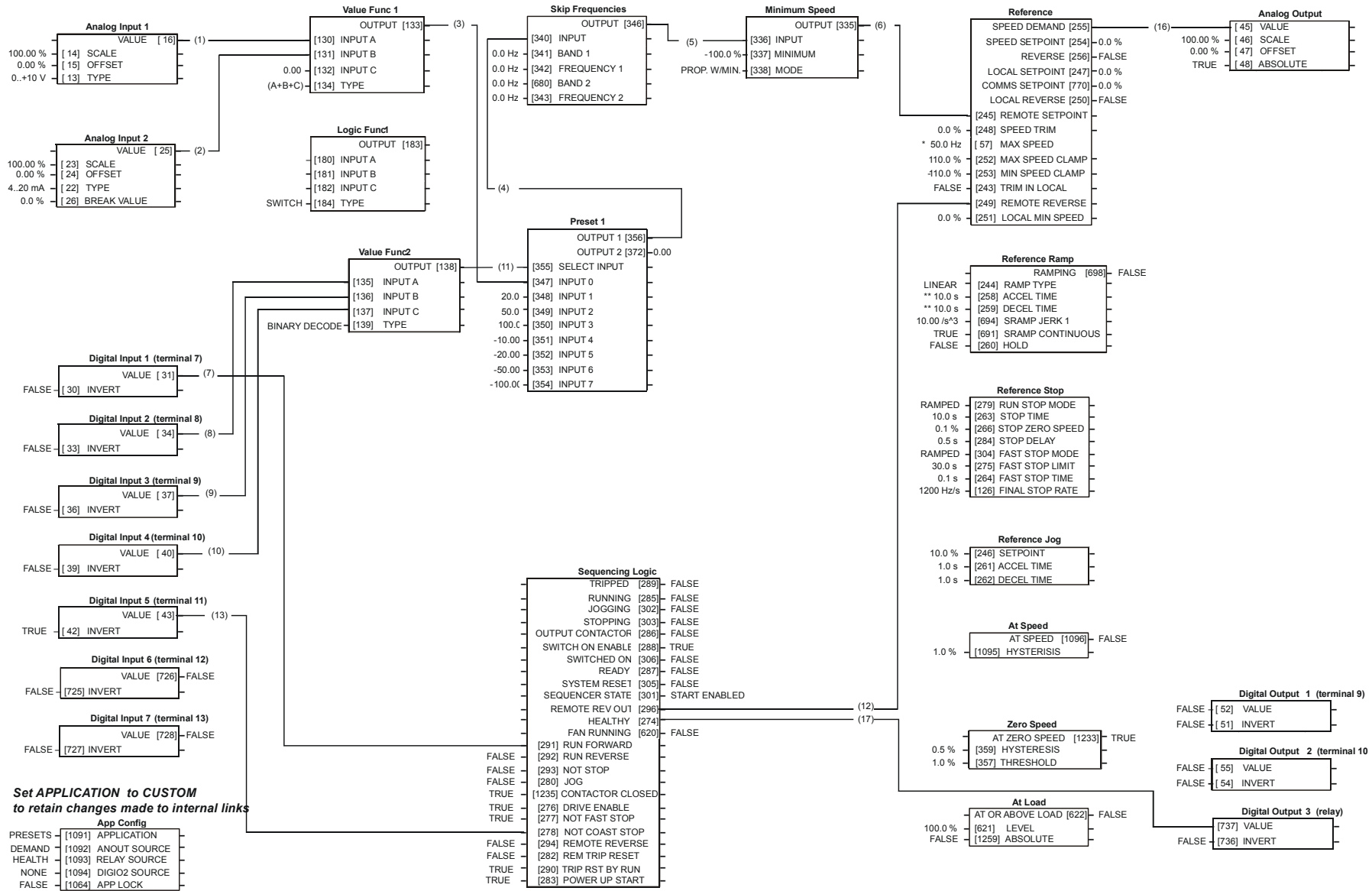

Application 3: Preset Speeds

Application 3: Preset Speeds

This is ideal for applications requiring multiple discrete speed levels.

The setpoint is selected from either the sum of the analogue inputs, (as in Application 1 and known here as PRESET 0), or as one of up to seven other pre-defined speed levels. These are selected using DIN2, DIN3 and DIN4, refer to the Truth Table below.

Edit parameters P302 to P308 on the keypad to re-define the speed levels of PRESET 1 to PRESET 7. Reverse direction is achieved by entering a negative speed setpoint.

Control Wiring I/O			
Terminal	Name	Purpose	Comment
13	DIGITAL INPUT 7	<i>Not configured</i>	<i>Not Used</i>
12	DIGITAL INPUT 6	<i>Not configured</i>	<i>Not Used</i>
11	DIGITAL INPUT 5	Not Coast Stop (inverted)	24V = coast to stop 0V = drive may run
	DIGITAL INPUT 4 DIGITAL INPUT 3 DIGITAL INPUT 2	Preset Select 3 Preset Select 2 Preset Select 1	Preset Speed Select Preset Speed Select Preset Speed Select
7	DIGITAL INPUT 1	Run Forward	24V = run forward
5	ANALOG OUTPUT 1	Ramp Output	absolute speed demand 0V = 0%, 10V = 100%
3	ANALOG INPUT 2	Speed Trim	4mA = 0%, 20mA = 100%
2	ANALOG INPUT 1	Speed Setpoint	0V = 0%, 10V = 100%
RL1A RL1B	DIGITAL OUTPUT 3 (relay)	HEALTH	Open = tripped, i.e. not healthy

Preset Speed Truth Table

DIN4/DOUT2	DIN3	DIN2	Preset
0V	0V	0V	0
0V	0V	24V	1
0V	24V	0V	2
0V	24V	24V	3
24V	0V	0V	4
24V	0V	24V	5
24V	24V	0V	6
24V	24V	24V	7

5-8 Applications

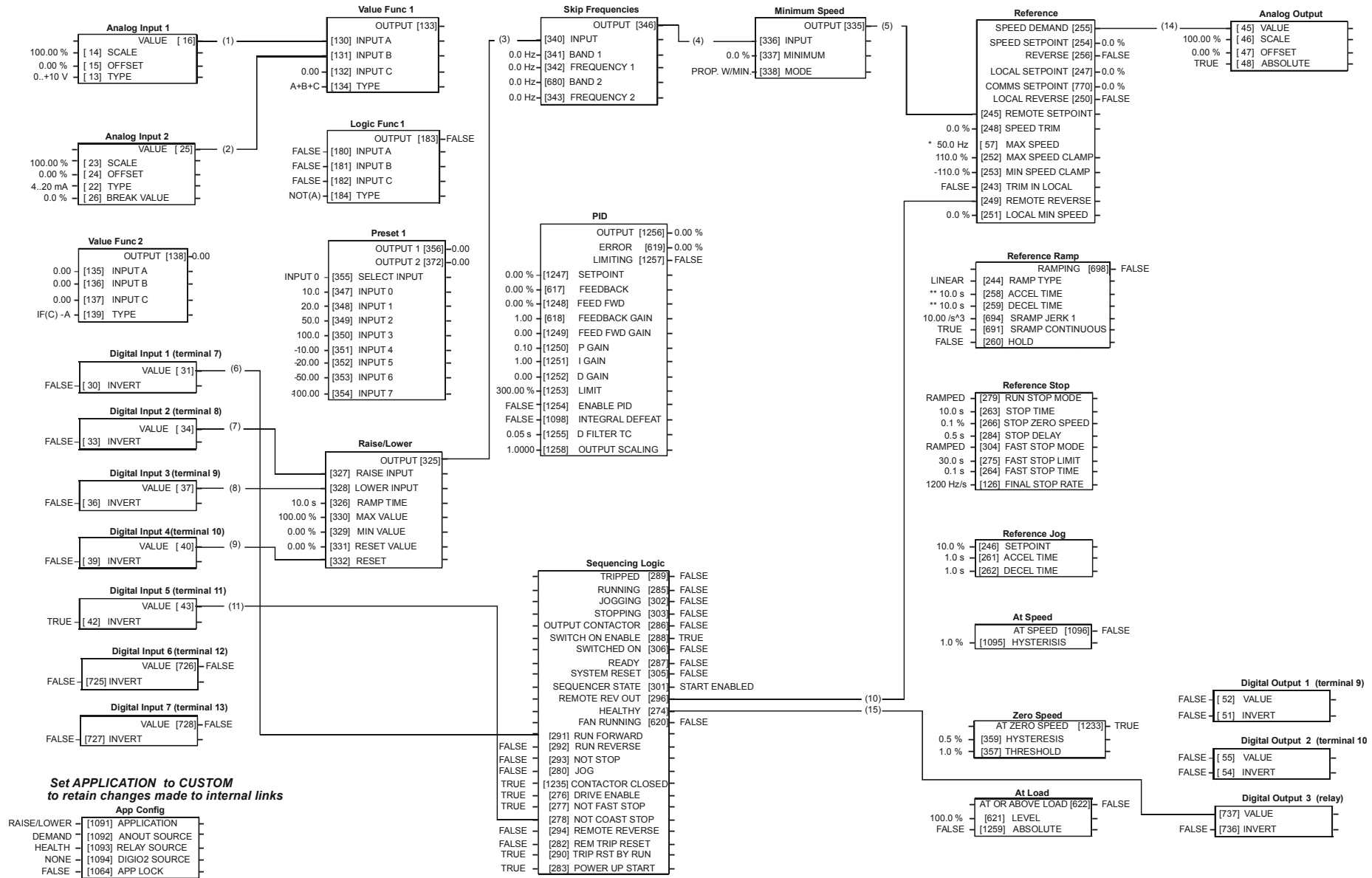

Application 4: Raise/Lower Trim

Application 4: Raise/Lower Trim

This Application mimics the operation of a motorised potentiometer. Digital inputs allow the setpoint to be increased and decreased between limits. The limits and ramp rate can be set using the keypad.

The Application is sometimes referred to as Motorised Potentiometer.

Control Wiring I/O			
Terminal	Name	Purpose	Comment
13	DIGITAL INPUT 7	<i>Not configured</i>	<i>Not Used</i>
12	DIGITAL INPUT 6	<i>Not configured</i>	<i>Not Used</i>
11	DIGITAL INPUT 5	Not Coast Stop (inverted)	24V = coast to stop 0V = drive may run
10	DIGITAL INPUT 4	Reset	24V = reset Raise/Lower
9	DIGITAL INPUT 3	Lower Input	24V = Lower inputl
8	DIGITAL INPUT 2	Raise Input	24V = raise input
7	DIGITAL INPUT 1	Run Forward	24V = run forward
5	ANALOG OUTPUT 1	Ramp Output	absolute speed demand 0V = 0%, 10V = 100%
RL1A RL1B	DIGITAL OUTPUT 3 (relay)	HEALTH	Open = tripped, i.e. not healthy

5-10 Applications

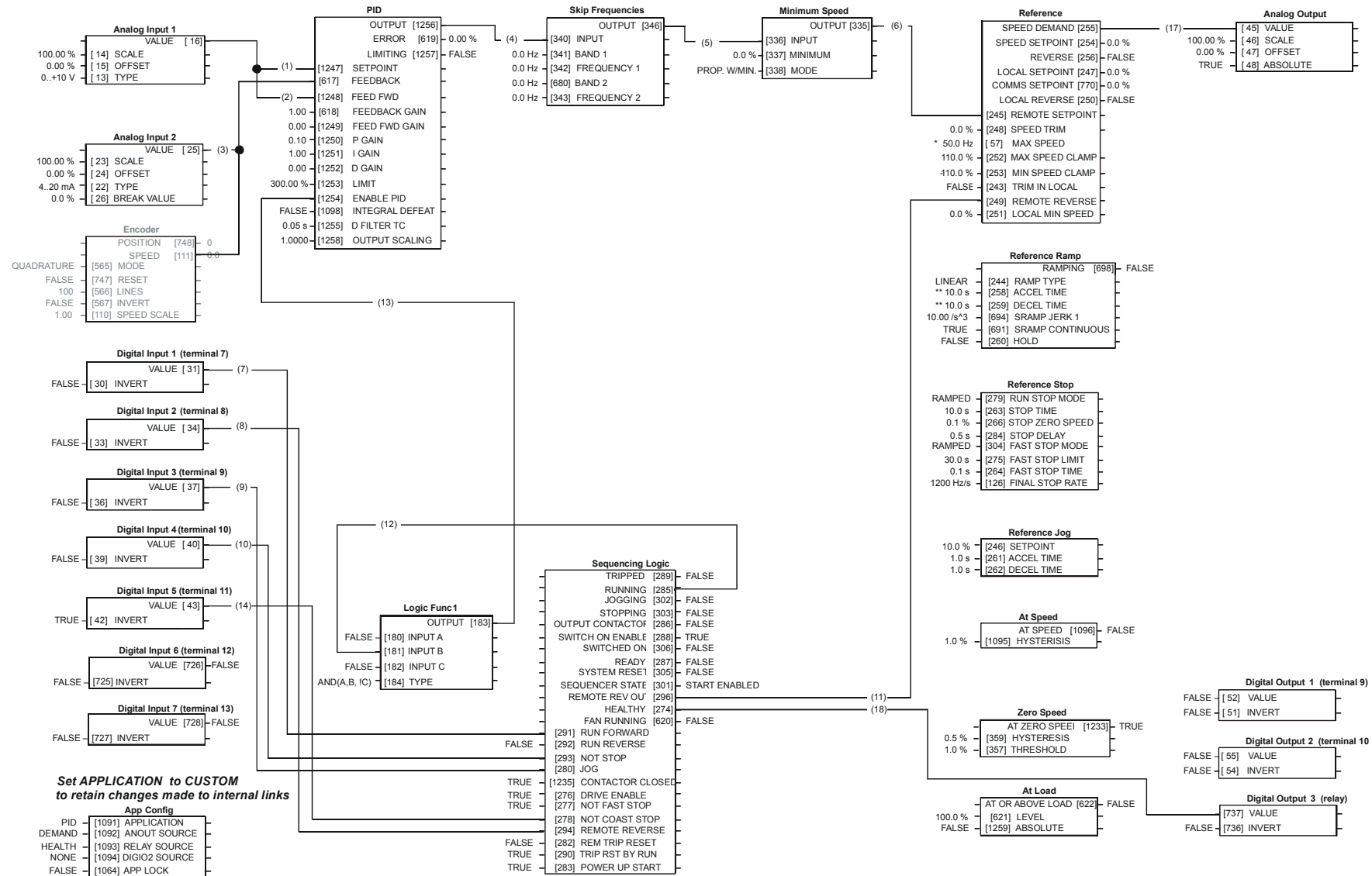

Application 5: PID

Application 5: PID

A simple application using a Proportional-Integral-Derivative 3-term controller. The setpoint is taken from AIN1, with feedback signal from the process on AIN2. The scale and offset features of the analogue input blocks may be used to correctly scale these signals. The difference between these two signals is taken as the PID error. The output of the PID block is then used as the drive setpoint.

Control Wiring I/O			
Terminal	Name	Purpose	Comment
13	DIGITAL INPUT 7	<i>Not configured</i>	<i>Not Used</i>
12	DIGITAL INPUT 6	<i>Not configured</i>	<i>Not Used</i>
11	DIGITAL INPUT 5	Not Coast Stop (inverted)	24V = coast to stop 0V = drive may run
10	DIGITAL INPUT 4	Not Stop	24V = RUN FWD and RUN REV signals latched 0V = RUN FWD and RUN REV signals not latched
9	DIGITAL INPUT 3	Jog	24V = jog
8	DIGITAL INPUT 2	Remote Reverse	0V = remote forward 24V = remote reverse
7	DIGITAL INPUT 1	Run Forward	24V = run forward
5	ANALOG OUTPUT 1	Ramp Output	absolute speed demand 0V = 0%, 10V = 100%
3	ANALOG INPUT 2	Process Feedback	0V = 0%, 10V = 100%
2	ANALOG INPUT 1	Process Setpoint	0V = 0%, 10V = 100%
RL1A RL1B	DIGITAL OUTPUT 3 (relay)	HEALTH	Open = tripped, i.e. not healthy

5-12 Applications

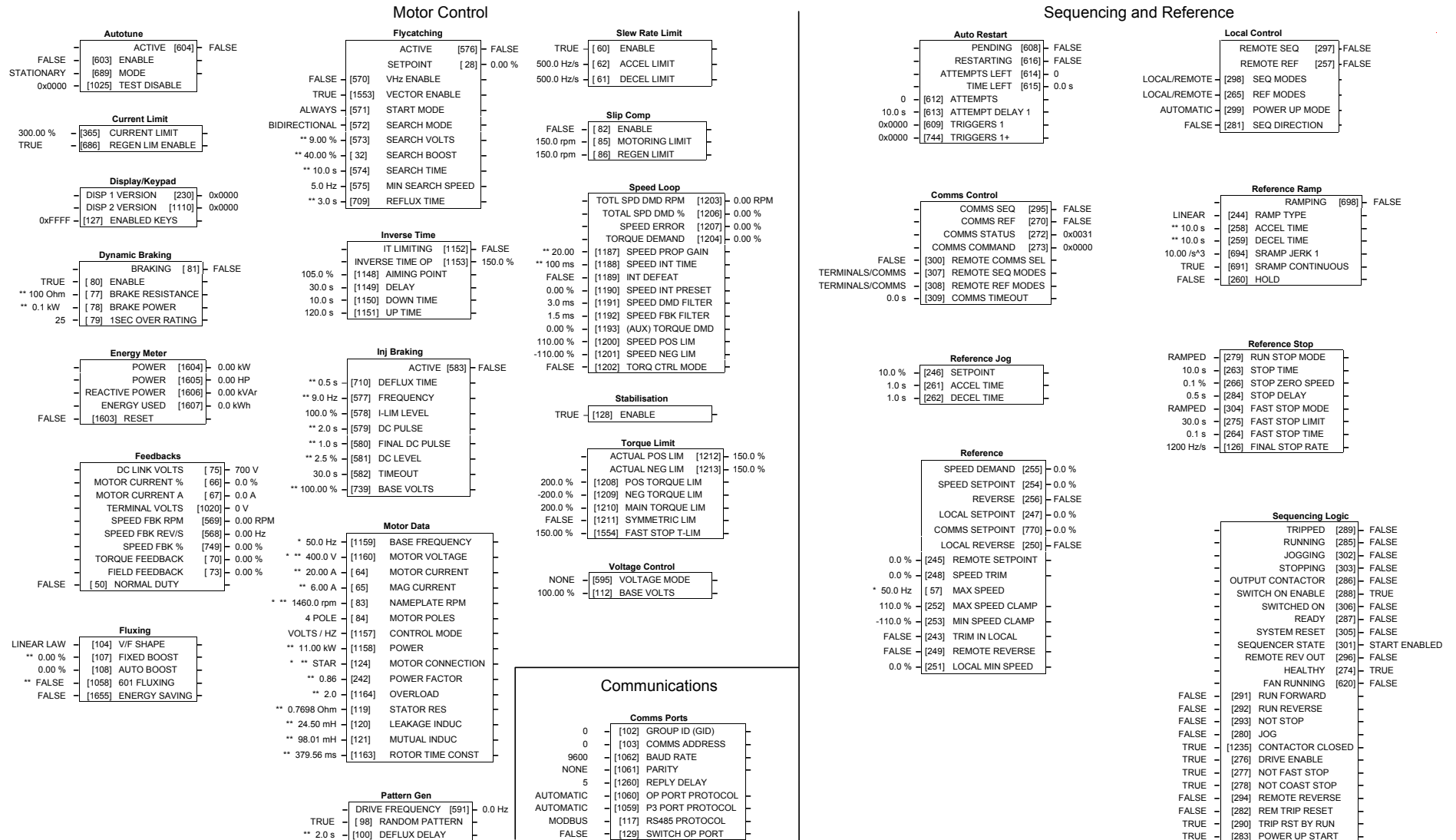

Some of these blocks may already be in use by the Applications

Application Control Blocks

Setpoint Functions

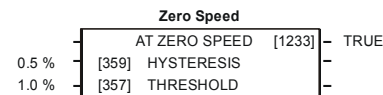
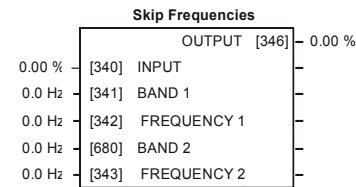
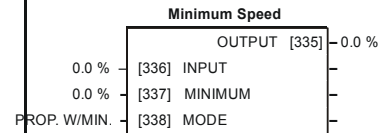
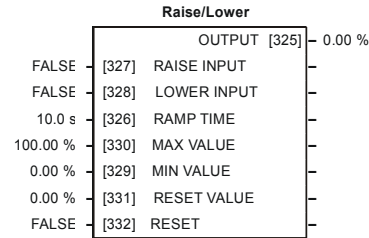
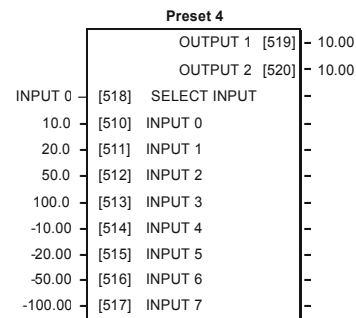
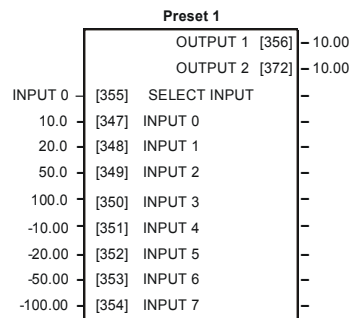
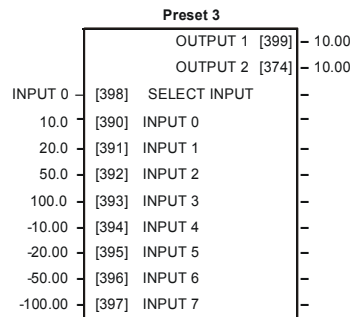
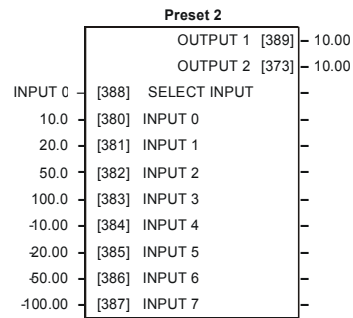
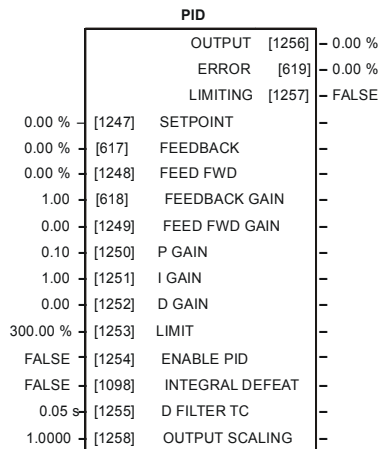
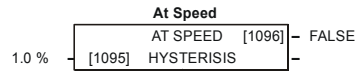
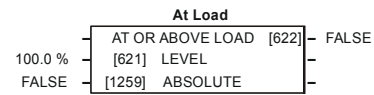

Trips

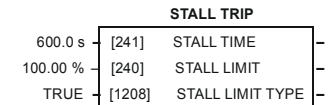
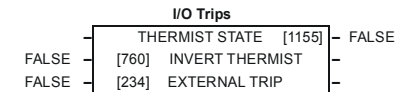
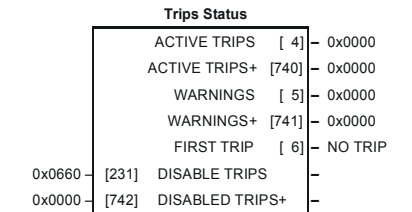
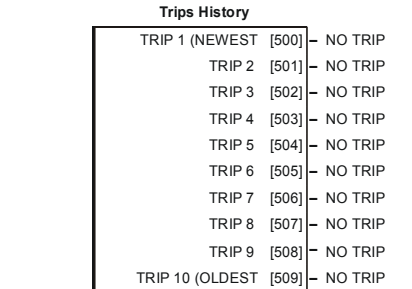

Hoist/Lift

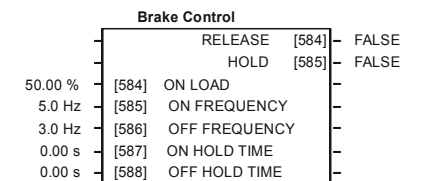

Some of these blocks may already be in use by the Applications

5-14 Applications

Miscellaneous

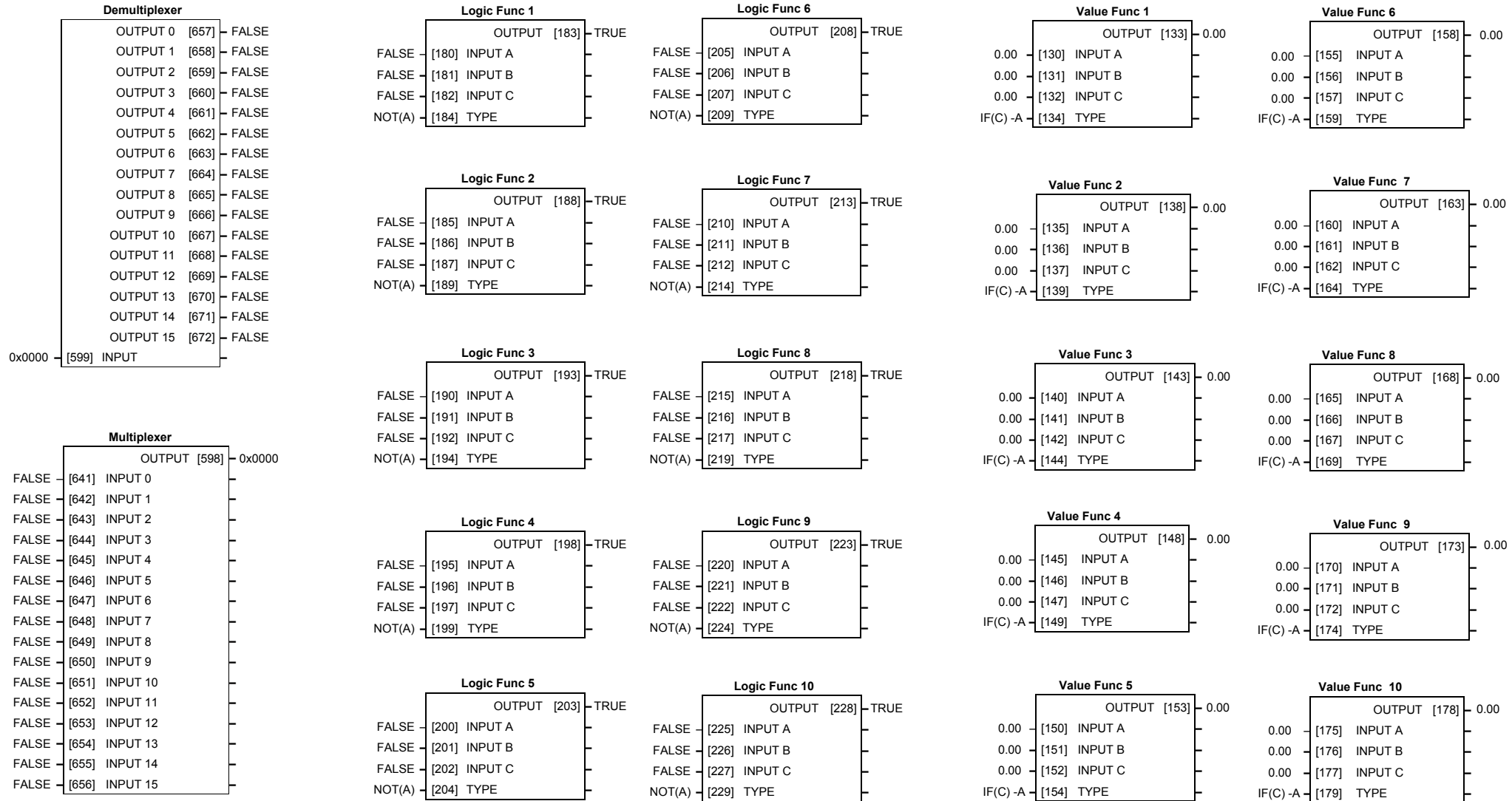

Some of these blocks may already be in use by the Applications

Menus

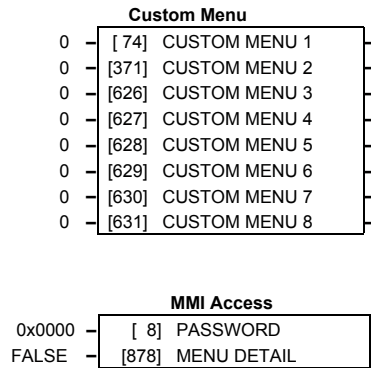

Encoder

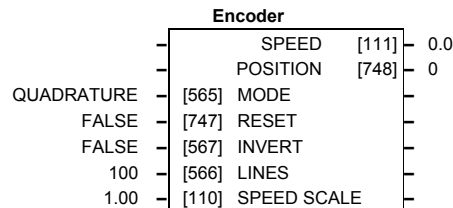

Inputs and Outputs

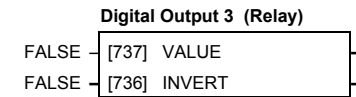
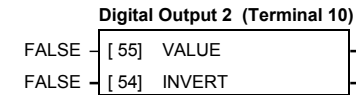
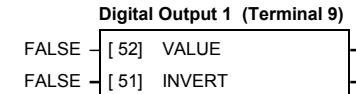
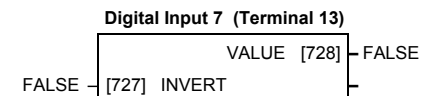
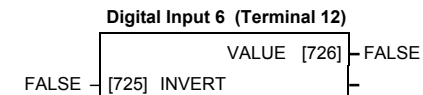
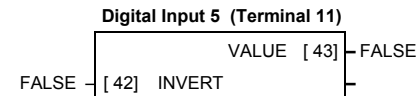
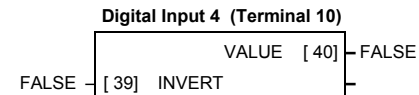
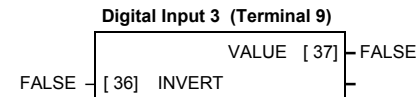
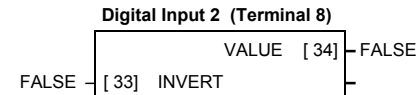
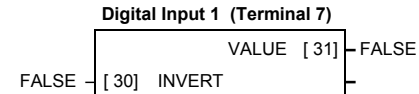
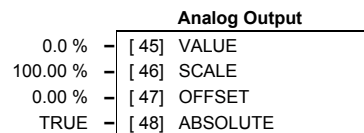
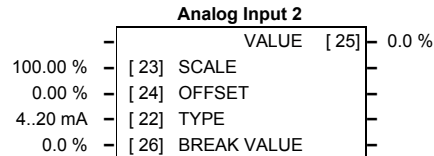
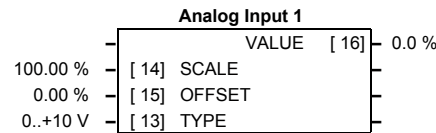
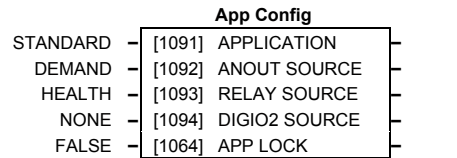

Some of these blocks may already be in use by the Applications

5-16 Applications

This manual was downloaded on www.sdsdrives.com
+44 (0)117 938 1800 - info@sdsdrives.com

ISS.	MODIFICATION	ECN No.	DATE	DRAWN	CHK'D
1	First release of new manual HA501038U001	20913	20 Feb 10	WS	FEP
FIRST USED ON		MODIFICATION RECORD			
		650G Software Product Manual Frames 1, 2, 3, C, D, E, F DRAWING NUMBER ZZ501028U001			SHT. 1 OF 1